

# SPECIFICATION

?



?



# Contents

?

1. Description	?	??
1.1 General Description	?	??
1.2 Features	?	??
1.3 Application	?	??
1.4 Package Dimension	?	??
1.5 Product Parameters	?	??
1.6 Typical Optical Characteristics Curves	?	??
2. Packaging	?	??
2.1 Packaging Specification	?	??
2.1.1 Carrier Tape Dimension	.....	11??
2.1.2 Reel Dimension	.....	11??
2.1.3 Label Form Specification	.....	12??
2.2 Moisture Resistant Packing	?	??
2.3 Cardboard Box	?	??
2.4 Reliability Test Items And Conditions	?	??
2.5 Criteria For Judging Damage		??
3. SMT Reflow Soldering Instructions SMT	?	??
3.1 SMT Reflow Soldering Instructions SMT	?	??
4. Handling Precautions	?	??
4.1 Handling Precautions	?	??

?

?

?

?

?

?



# 1. Description

## 1.1 General Description

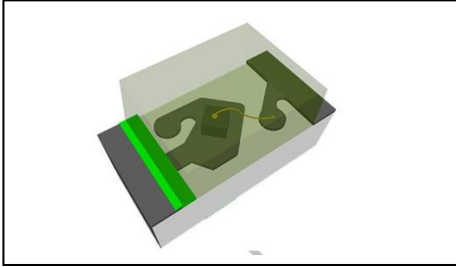

The Colour LED which was fabricated using a yellow green chip Package Dimension : 1.6mmX0.8mmX0.98mm.

LED

1.6mmX0.8mmX0.98mm

## 1.2 Features

Extremely wide viewing angle.

Suitable for all SMT assembly and solder process.

Moisture sensitivity level: Level 3.

RoHS compliant.

RoHS

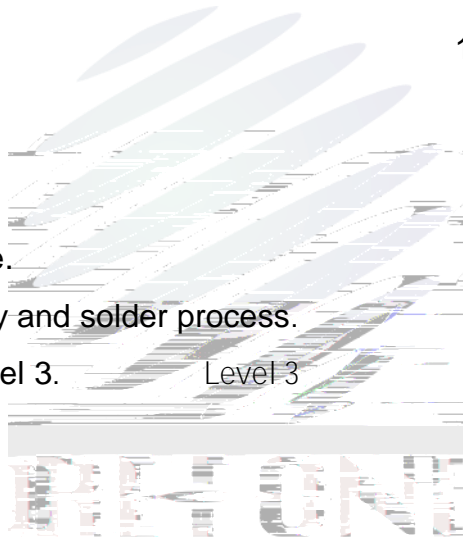

SMT

Level 3

## 1.3 Application

Optical indicator.

Switch and symbol, display.

General use.



### 1.4 Package Dimension

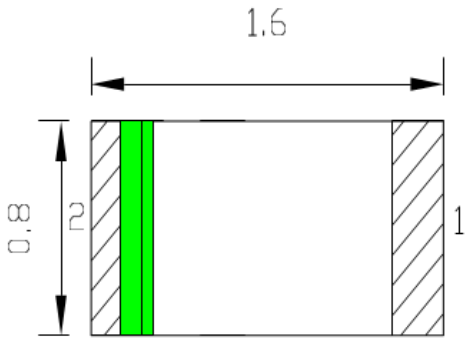

Fig.1-1 Top view

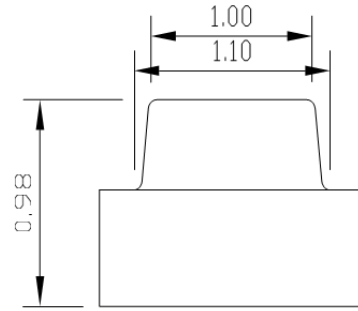

Fig.1-2 Side view

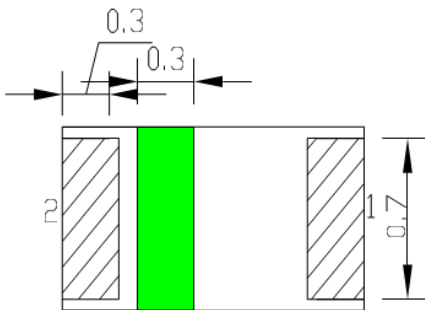

Fig.1-3 Bottom view

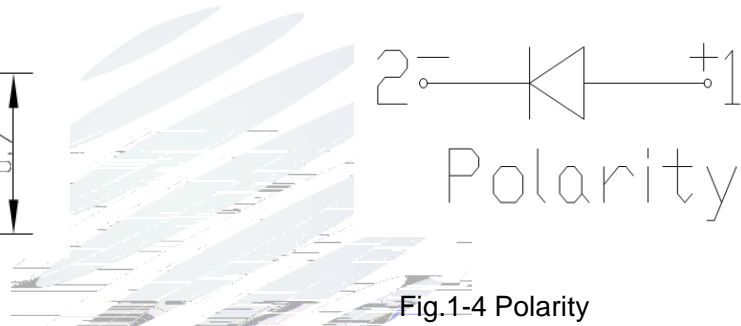

Fig.1-4 Polarity

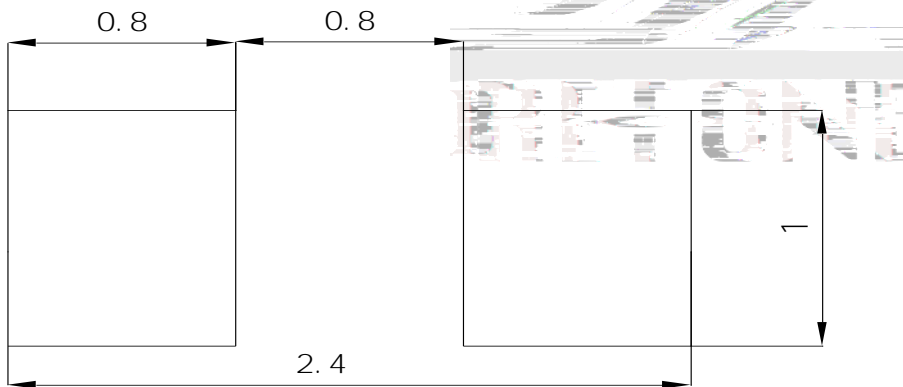

Fig.1-5 Soldering patterns

Notes

1. All dimensions units are millimeters.

All dimensions tolerances are  $\pm 0.2\text{mm}$  unless otherwise noted.



$\pm 0.2$  2

2

# 1.5 Product Parameters



Table 1-1 Electrical / Optical Characteristics at Ts=25°C

Item	Test Condition	Symbol	Value			Unit	
			Min. ( )	Typ.	Max.		
Spectral Half Bandwidth	$I_F=20mA$	$\Delta$	--	15	--	nm	
Forward Voltage	$I_F=20mA$	$V_F$	B1	1.8	-- <sup>②</sup>	1.9	V
			B2	1.9	-- <sup>②</sup>	2.0	V
			C1	2.0	-- <sup>②</sup>	2.1	V
			C2	2.1	-- <sup>②</sup>	2.2	V
			D1	2.2	-- <sup>②</sup>	2.3	V
			D2	2.3	-- <sup>②</sup>	2.4	V
Dominant Wavelength	$I_F=20mA$	$\lambda_D$	①	②	③	④	nm
			⑤	⑥	⑦	⑧	nm
			⑨	⑩	⑪	⑫	nm
			⑬	⑭	⑮	⑯	nm
Luminous Intensity	$I_F=20mA$	$I_v$	①	②	③	④	mcd
			⑤	⑥	⑦	⑧	mcd
			⑨	⑩	⑪	⑫	mcd
Viewing Angle	$I_F=20mA$	" ! "	--	140	--	deg	
Reverse Current	$V_R=5V$	$I_R$					

Notes :  $V_R=5V$  For test conditions.  $V_R=5V$

Table 1-2 Absolute Maximum Ratings at Ts=25°C

Parameter	Symbol	Rating	Units
Power Dissipation	$P_d$	72	mW
Forward Current	$I_F$	30	mA
Peak Forward Current Of Pulse	$I_{FP}$	60	mA
Reverse Voltage 	$V_r$	5	V
Electrostatic Discharge (HBM)	$E_{SD}$	2000	V
Operating Temperature	$T_{opr}$	-40 ~ +85	°C
Storage Temperature	$T_{stg}$	-40 ~ +85	°C
Junction Temperature	$T_j$	95	°C

Notes

- 1/10 Duty cycle, 0.1ms pulse width. 0.1ms, 1/10.
- The above forward voltage measurement allowance tolerance is  $\pm 0.1V$ .  $\pm 0.1V$ .
- The above dominant wavelength measurement allowance tolerance is  $\pm 2nm$ .  $\pm 2nm$ .
- The above luminous intensity measurement allowance tolerance  $\pm 10\%$ .  $\pm 10\%$ .
- Care is to be taken that power dissipation does not exceed the absolute maximum rating of the product.
- All measurements were made under the standardized environment of Refond.
- When the LEDs are in operation the maximum current should be decided after measuring the package temperature, junction temperature should not exceed the maximum rate. LED

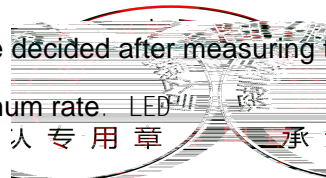

## 1.6 Typical Optical Characteristics Curves

2

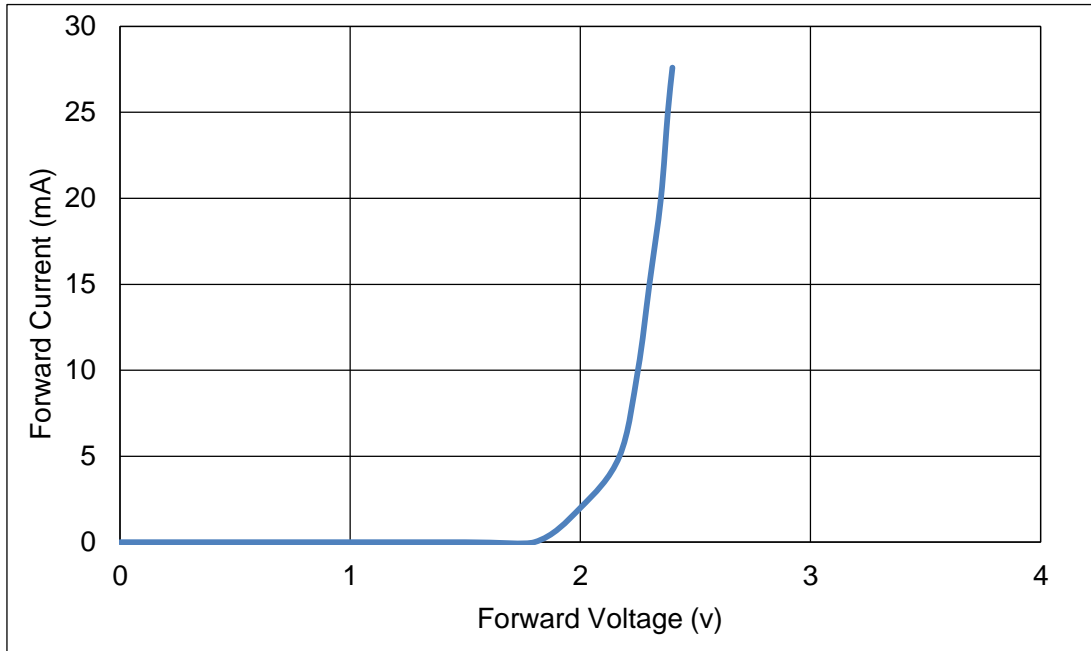

Fig 1-6 Forward Voltage Vs Forward Current

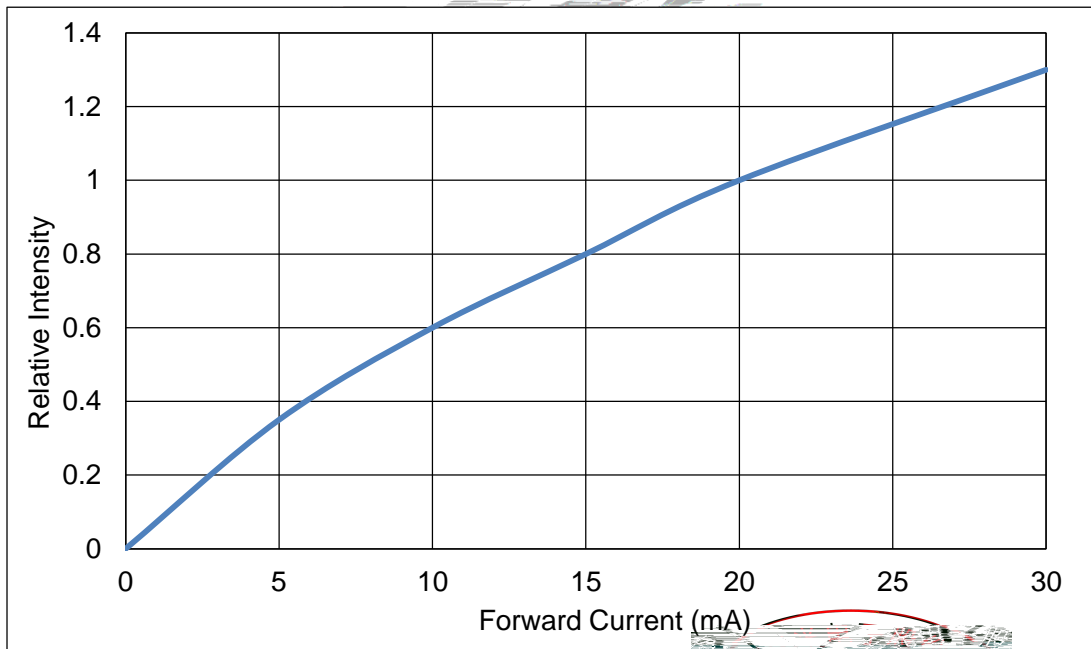
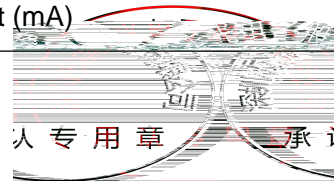

Fig 1-7 Forward Current Vs Relative Intensity



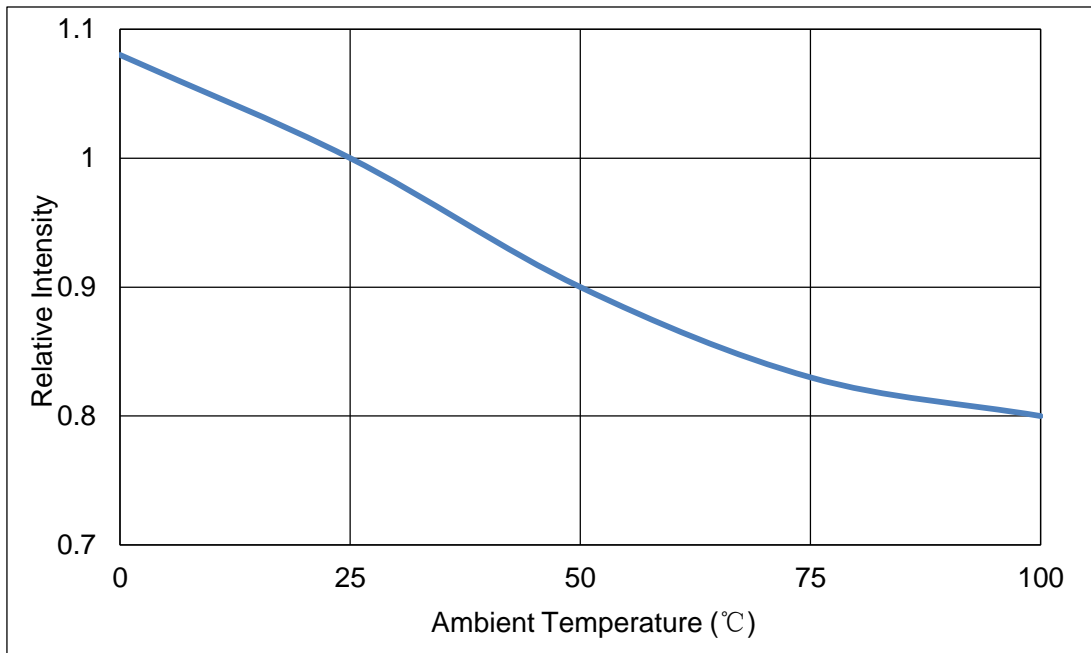

Fig 1-8 Pin Temperature Vs Relative Intensity

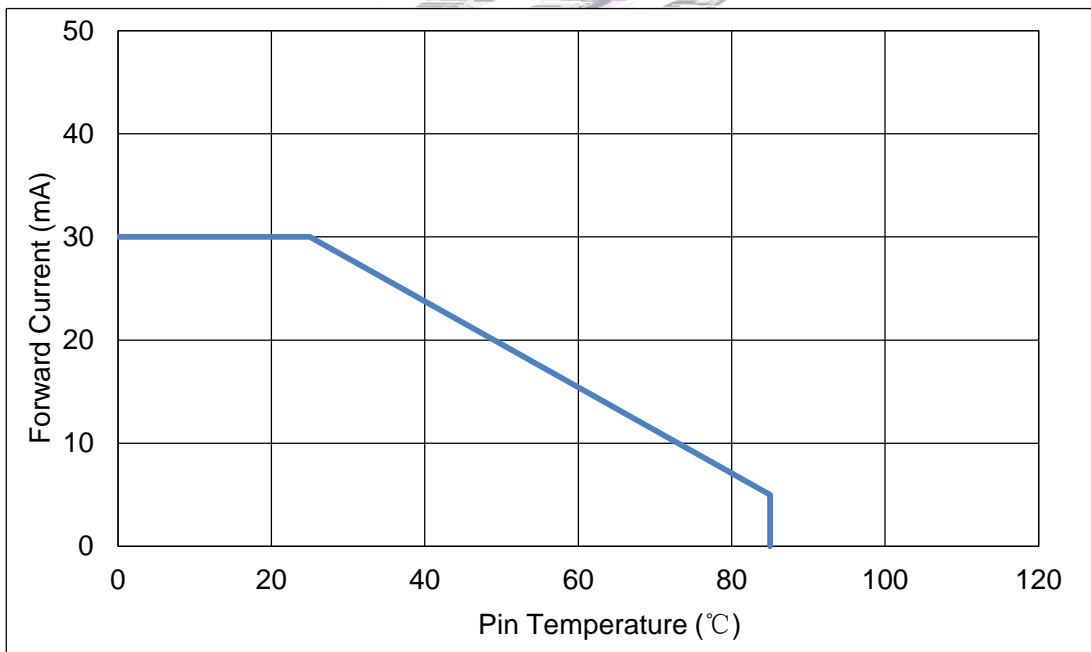

Fig 1-9 Pin Temperature Vs Forward Current





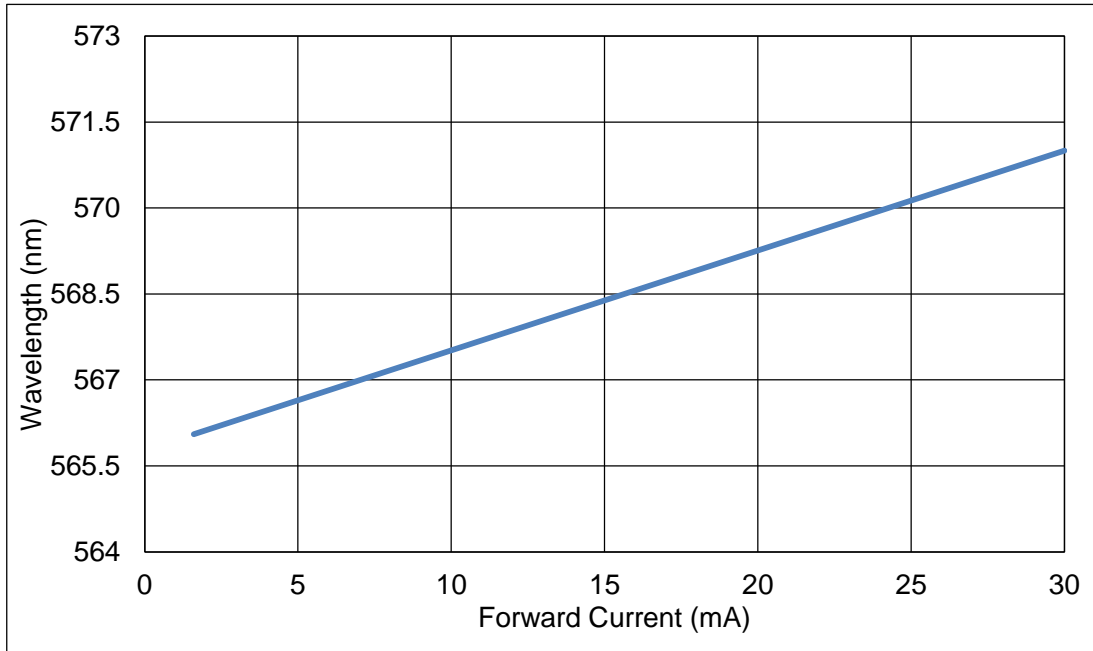

Fig 1-10 Forward Current Vs Dominate Wavelength (Ta=25°C)

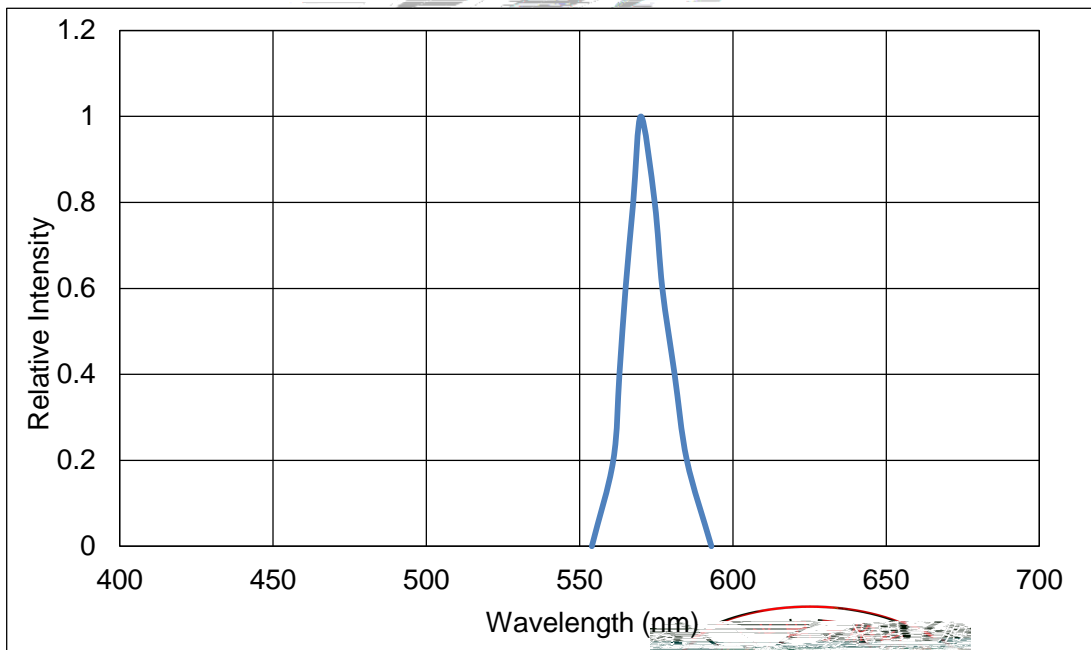

Fig 1-11 Relative Intensity Vs Wavelength (Ta=25°C)

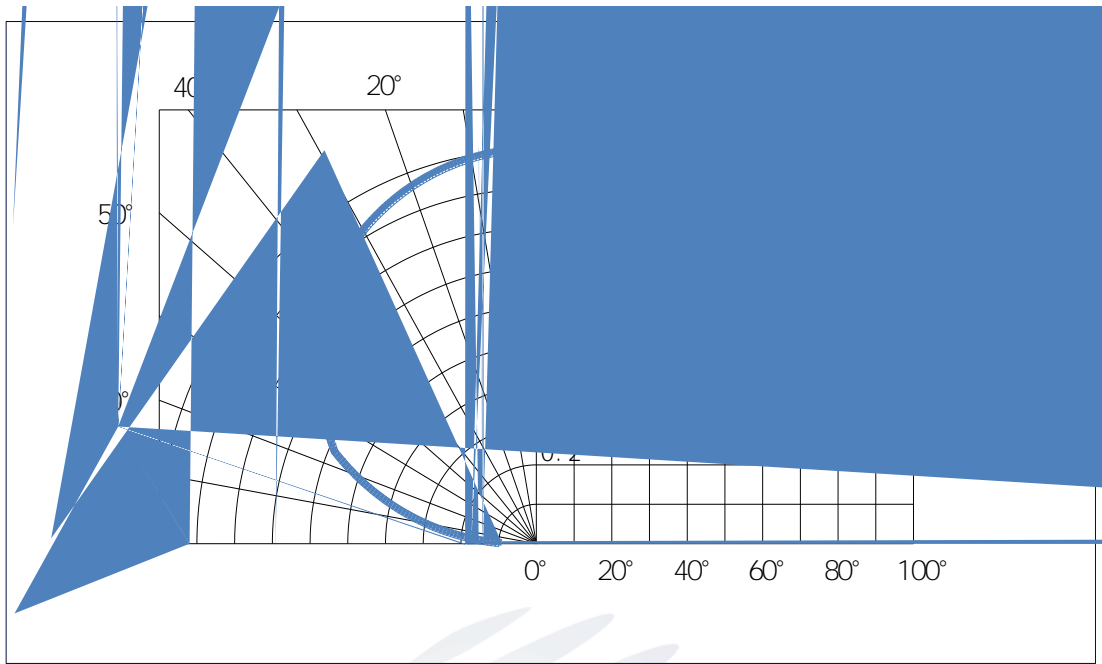
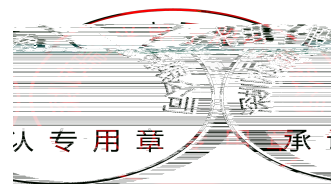

Fig 1-12 Diagram characteristics of radiation

2



2



## 2. Packaging

☐

### 2.1 Packaging Specification

Package:4000pcs/reel. 4000pcs ☐

☐

#### 2.1.1 Carrier Tape Dimension

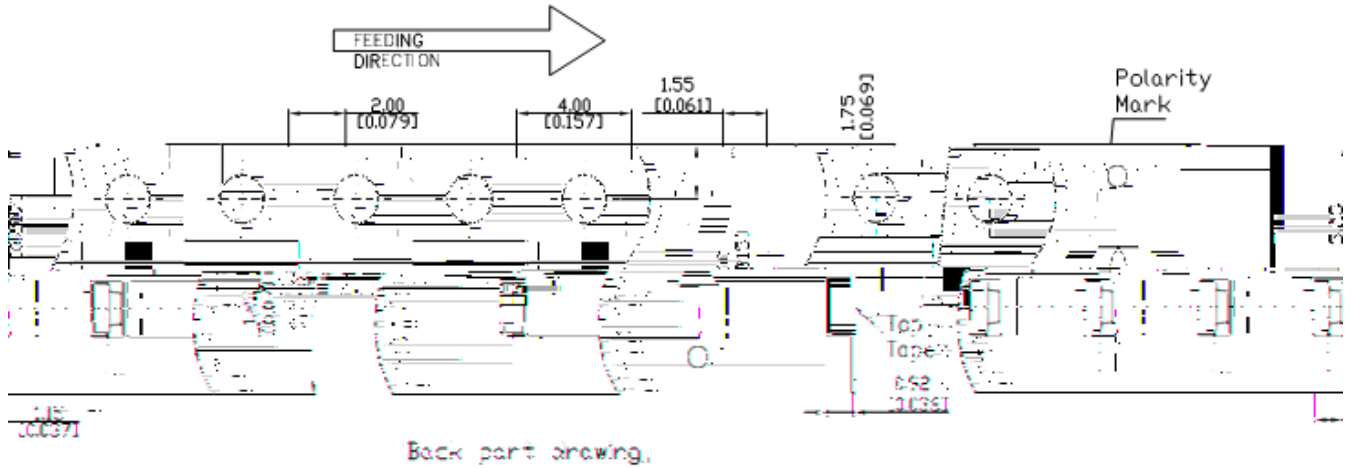

☐

Fig.2-1 Carrier Tape Dimension ☐

☐

#### 2.1.2 Reel Dimension

☐

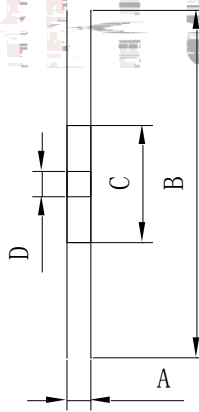
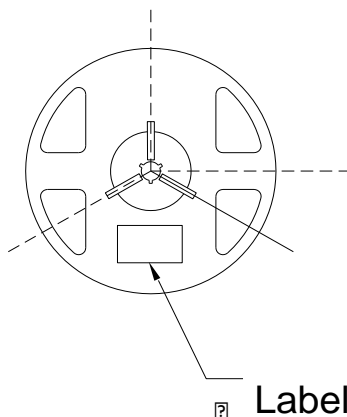

Table 2-1 Dimension ☐

A	8.0± 0.1mm
B	178± 1mm
C	60± 1mm
D	13.0± 0.5mm

☐

☐ Label 标签

☐

Fig.2-2 Reel Dimension

☐

#### Notes

The tolerances unless mentioned ±0.1mm. Unit : mm

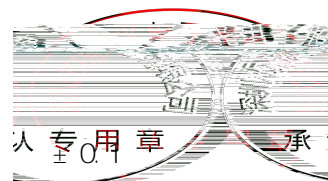

### 2.1.3 Label Form Specification

?

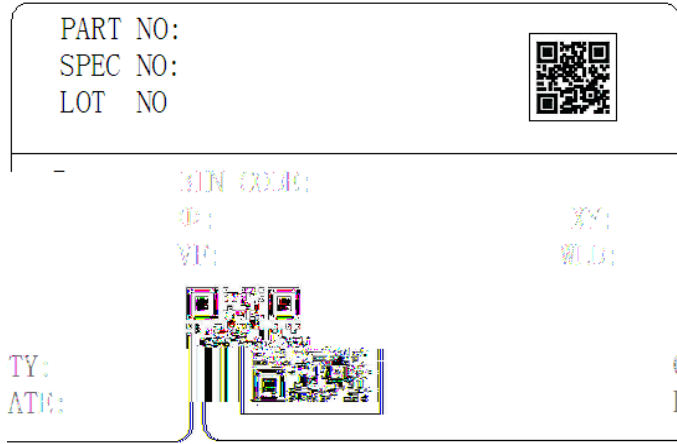

Fig. 2-3 Label Form Specification

Table 2-2 Parameter

PART NO.	Part Number
SPEC NO.	Spec Number
LOT NO.	Lot Number
BIN CODE	Bin Code
	Luminous flux
XY	Chromaticity Bin
V <sub>F</sub>	Forward Voltage
WLD	Wavelength
QTY	Packing Quantity
DATE	Made Date

?

?

### 2.2 Moisture Resistant Packing

?

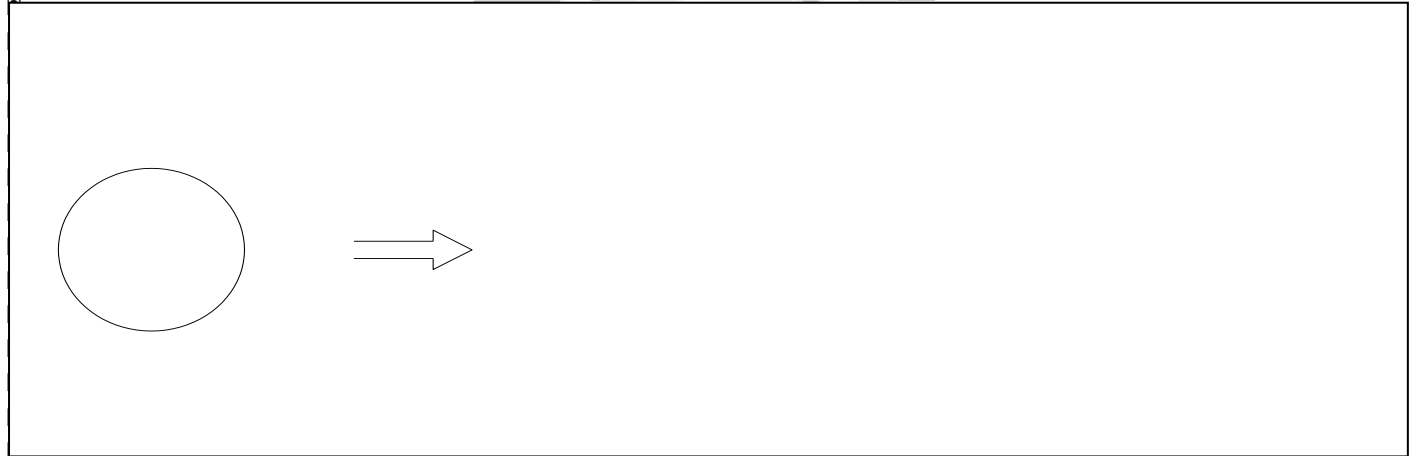

Fig.2-4 Moisture Resistant Packing

?

?

?

?

?

?

?

?

?

?

?

?



## 2.3 Cardboard Box

2  
2

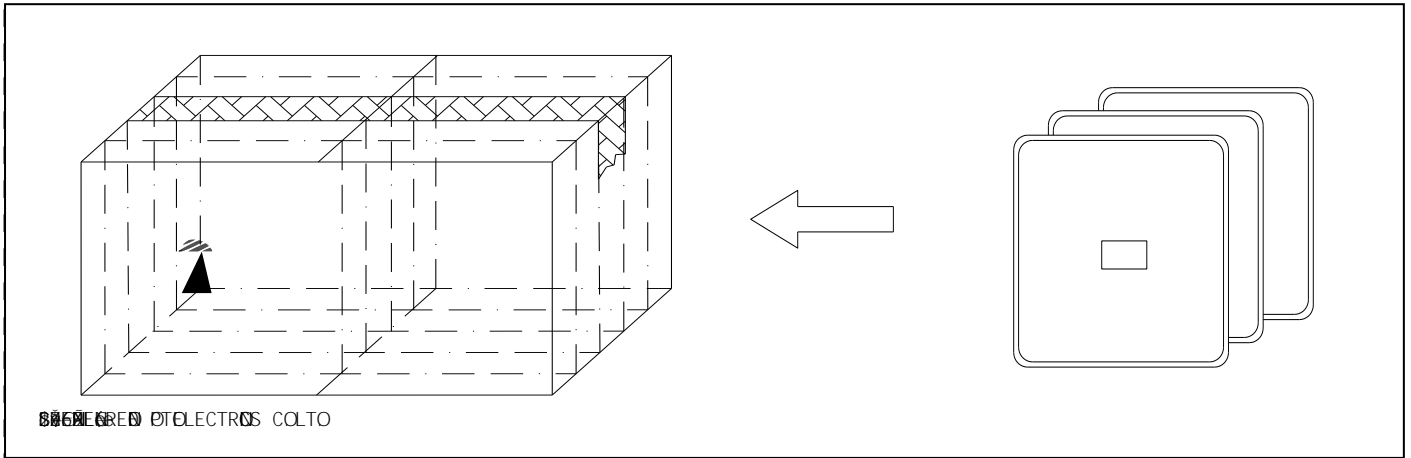

Fig.2-5 Cardboard Box

## 2.4 Reliability Test Items And Conditions

2

Table 2-3 Reliability Test Items And Conditions

Test Items	Ref.Standard	Test Condition	Time	Quantity	Ac/Re /
Reflow	JESD22-B106	Temp:260 max T=10 sec	2 times	22Pcs.	0/1
Temperature Cycle	JESD22-A104	100 30 min 5 min -40 30 min	100 cycles	22Pcs.	0/1
Thermal Shock	JESD22-A106	-40 15min 100 15min	300 cycles	22Pcs.	0/1
High Temperature Storage	JESD22-A103	Temp:100	1000 hrs.	22Pcs.	0/1
Low Temperature Storage	JESD22-A119	Temp:-40	1000 hrs.	22Pcs.	0/1
Life Test	JESD22-A108	T <sub>a</sub> =25 I <sub>F</sub> =20mA	1000 hrs.	22Pcs.	0/1

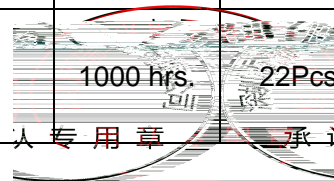

## 2.5 Criteria For Judging Damage



Table 2-4 Criteria For Judging Damage

Test Items	Symbol	Test Condition	Criteria For Judgement	
			Min.	Max.
Forward Voltage	$V_F$	$I_F=20mA$	-	U.S.L*)x1.1
Reverse Current	$I_R$	$V_R= 5V$	-	U.S.L*)x2.0
Luminous Flux		$I_F=20mA$	L.S.L*)x0.7	-

### Notes

1.U.S.L: Upper standard level

L.S.L: Lower standard level

2.The above reliability tests is based on the verification of a single/strip LED of Refond's existing experimental platform,the reliability experiment was taken under good heat dissipation conditions. When customers applies the LED to the series and parallel circuit,should take consideration of all the factors such as the current, voltage distribution, heat dissipation and others.

LED

3.The technical information shown in the data sheets is limited to the typical characteristics and circuit examples of the referenced products. It does not constitute the warranting of industrial property nor the granting of any license.





### 3. SMT Reflow Soldering Instructions SMT 回流焊说明

#### 3.1 SMT Reflow Soldering Instructions SMT

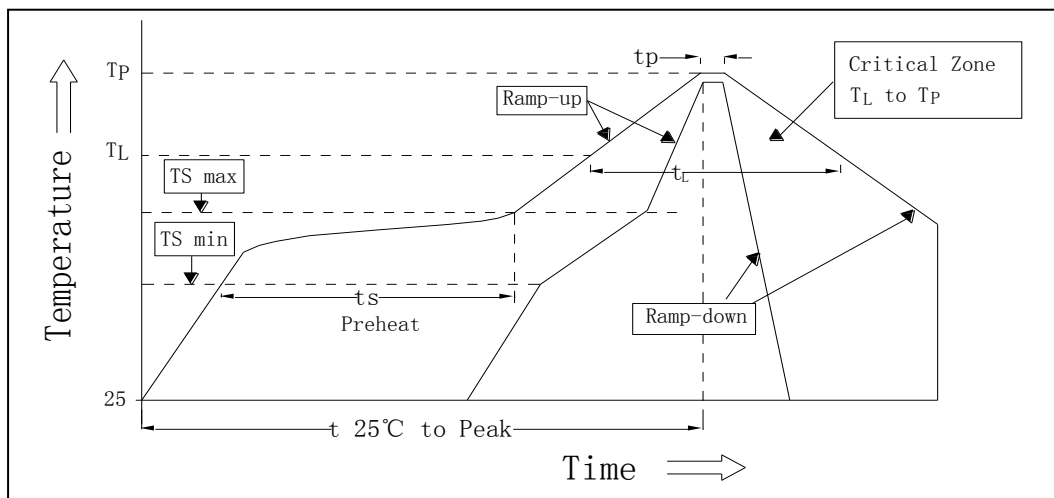

Fig.3-1 SMT Reflow Soldering Instructions SMT

Table 3-1 Parameters

Average temperature rise speed	Tsmax / T <sub>P</sub>	3 °C/ s	Max 3 °C/ s
Preheating: minimum temperature	(Tsmin)	150 °C	
Preheating: Max temperature	(Tsmax)	200 °C	
Preheating: Time	Tsmin / Tsmax	60 - 120	60s-120s
Time limited to maintain high temperature: the temperature (T <sub>L</sub> )		217 °C	
Time limited to maintain high temperature: The Time (t <sub>L</sub> )		60	Max 60s
Peak /Classification of temperature: / (T <sub>P</sub> )		260 °C	
Time limit classification of peak temperature time t <sub>p</sub>		10	Max 10s
(T <sub>P</sub> ) 5 °C Hold time within 5 °		30	Max 30s
C with the actual peak temperature (T <sub>P</sub> )			
Cooling speed		6 °C/ s	Max 6 °C/ s
25 °C	Needed time from 25 °C to T <sub>p</sub>	8	Max 8 minutes

Notes

(1)Reflow soldering should not be done more than twice. If more than 24 hours between the two solderings, LED will be damaged. 24 LED

(2)When soldering , do not put stress on the LEDs during heating.

3.1.1 Soldering Iron

(1) When do soldering by hand, keep the temperature of iron below less 300°C less than 3 seconds. 300 3

(2) Soldering by hand should be done only one time.

3.1.2 Repairing

Repairing should not be done after the LEDs have been soldered. When repairing is unavoidable,a double-head soldering iron should be used (as below figure). It should be confirmed in advance whether the characteristics of LEDs will or not be damaged by repairing.

LED

LED

3.1.3 Cautions

(1) The encapsulated material of the LEDs is silicone. Therefore the LEDs have a soft surface on the top of package. The pressure to the top surface will be impacted on the reliability of the LEDs. Precautions should be taken to avoid the strong pressure on the encapsulated part. So when use the picking up nozzle, the pressure on the silicone resin should be proper. LED

LED

(2) Components should not be mounted on warped (non coplanar) portion of PCB. After soldering, do not warp the circuit board.LED PCB

(3) Do not apply mechanical force or excess vibration during the cooling process to normal temperature after soldering. Do not rapidly cool device after soldering.



2



## 4. Handling Precautions

### 4.1 Handling Precautions

(1) LED operating environment and sulfur element composition cannot be over 100PPM in the LED mating usage material. This is provided for informational purposes only and is not a warranty or endorsement. LED LED 100PPM.

(2) In order to prevent external material from getting into the inside of LED, which may cause the malfunction of LED, the single content of Bromine element is required to be less than 900PPM, the single content of Chlorine element is required to be less than 900PPM, the total content of Bromine element and Chlorine element in the external materials of the application products is required to be less than 1500PPM. This is provided for informational purposes only and is not a warranty or endorsement.

LED LED  
900PPM 900PPM  
1500PPM.

(3) VOCs (Volatile organic compounds) emitted from materials used in the construction of fixtures can penetrate silicone encapsulants of LEDs and discolor when exposed to heat and photonic energy. The result can be a significant loss of light output from the fixture. Knowledge of the properties of the materials selected to be used in the construction of fixtures can help prevent these issues. Refond advises against the use of any chemicals or materials that have been found or are suspected to have an adverse affect on device performance or reliability. To verify compatibility, Refond recommends that all chemicals and materials be tested in the specific application and environment for which they are intended to be used. Attaching LEDs, do not use adhesives that outgas organic vapor.

LED  
LED

LED











Declare

This specification is written both in English and in Chinese and the latter is formal.



☐