

SPECIFICATION

产品规格书

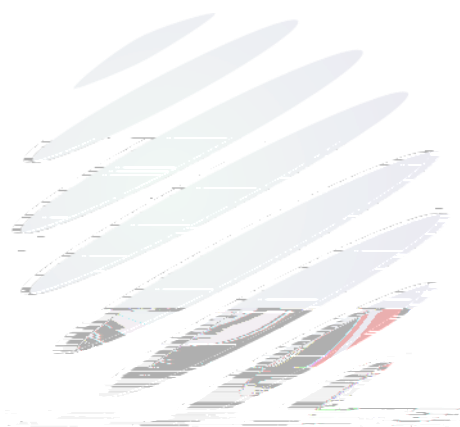

REFOND P/N 产品型号

RF-A1P14-W455-A4

R&D 研发

Mass Production 量产供货



Contents 目录

| | |
|--|--|
| 1. Description 产品介绍 | |
| 1.1 General Description 产品描述 | |
| 1.2 Features 产品特征 | |
| 1.3 Application 产品应用 | |
| 1.4 Package Dimension 封装尺寸 | |
| 1.5 Product Parameters 产品参数 | |
| 1.6 Bin Range Of Forward Voltage and Luminous Intensity (IF=20mA)电压与发光强度分 BIN 范围 (IF=20mA) | |
| 1.7 Typical Optical Characteristics Curves 典型光学特性曲线 | |
| 2. Packaging 产品包装 | |
| 2.1 Packaging Specification 包装规格 | |
| 2.1.1 Carrier Tape Dimension 载带尺寸 | |
| 2.1.2 Reel Dimension 卷盘尺寸 | |
| 2.1.3 Label Form Specification 标签规格 | |
| 2.2 Moisture Resistant Packing 防潮包装 | |
| 2.3 Cardboard Box 包装纸箱 | |
| 2.4 Reliability Test Items And Conditions 信赖性测试项目及条件 | |
| 2.5 Criteria For Judging Damage 失效判定标准 | |
| 3. SMT Reflow Soldering Instructions SMT 回流焊说明 | |
| 3.1 SMT Reflow Soldering Instructions SMT 回流焊说明 | |
| 4. Handling Precautions 产品使用注意事项 | |
| 4.1 Handling Precautions 产品使用注意事项 | |



1. Description 产品介绍

1.1 p ph h 产品描述



The White LED, which was fabricated by using a blue chip and the phosphor.

Product Package: 2.20mmX1.40mmX1.30mm.

该产品为白色光 LED，是由蓝光芯片激发荧光粉而形成。产品尺寸：2.20mmX1.40mmX1.30mm.

1.2 Features 产品特征

PLCC Package. PLCC封装

Extremely wide viewing angle. 发光角度大

Suitable for all SMT assembly and solder process. 适用于所有的SMT组装和焊接工艺

Available on tape and reel. 适用于载带及卷轴

Moisture sensitivity level: Level 2. 防潮等级 Level2

Compliance with RoHS and REACH. 符合RoHS和REACH要求

Qualifications: The product qualification test plan is based on the guidelines of AEC-Q101

Stress Test Qualification for Automotive Grade Discrete Semiconductors 资格：产品资格测试计划基于AEC-Q101汽车级分立半导体应力测试资格准则

1.3 Application 产品应用

Automotive Lighting Interior. 汽车内饰照明



1.4 Package Dimension 封装尺寸

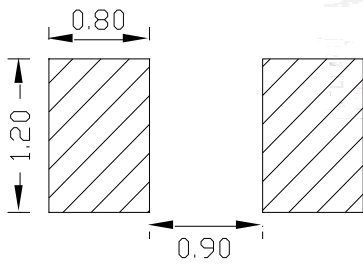
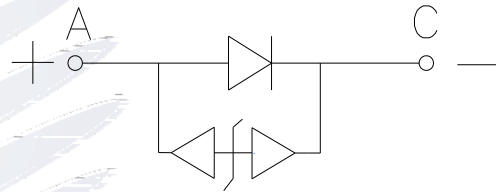
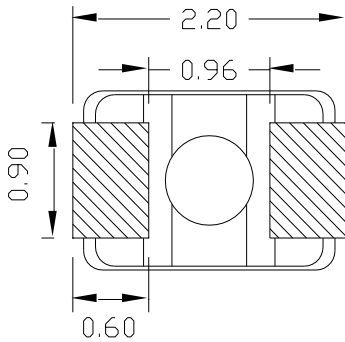
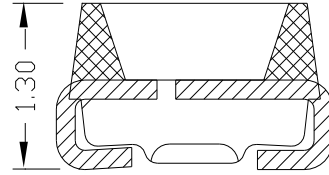
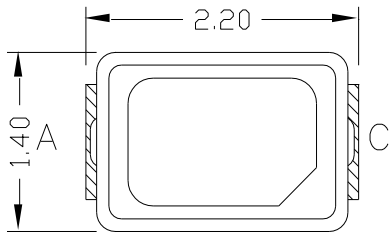

Notes 备注:

1. All dimensions units are millimeters. 所有尺寸标注单位为毫米
2. All dimensions tolerances are 0.20mm unless otherwise noted. 除特别标注外, 所有尺寸公差均为±0.20 毫米





1.6Bin Range Of Forward Voltage and Luminous Intensity (IF=20mA)电压与发光强度分 BIN 范围(IF=20mA)

Table 1-3

| V_F V | E2 | F1 | F2 | G1 | G2 | H1 |
|---------|----|----|----|----|----|----|
|---------|----|----|----|----|----|----|

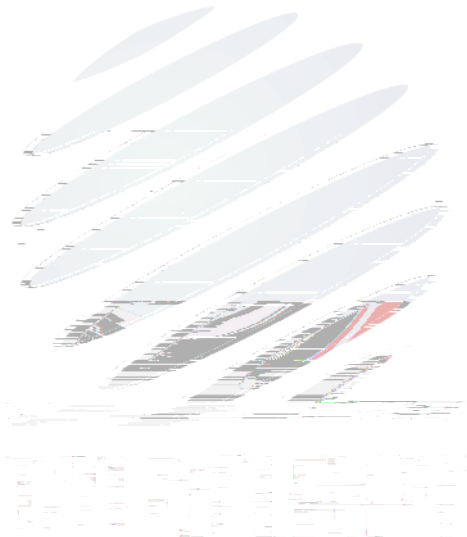

1.7 Typical Optical Characteristics Curves 典型光学特性曲线

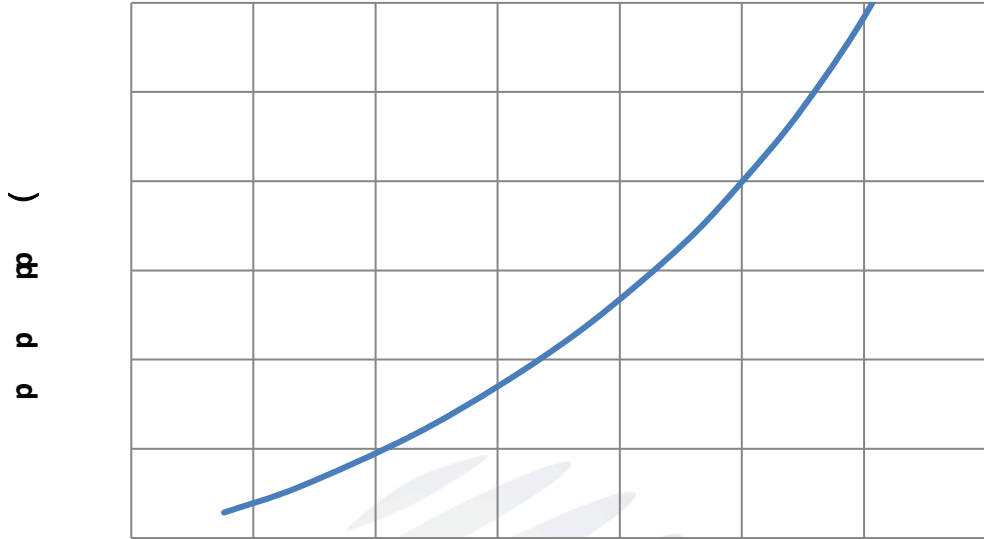

Fig. 1-7 Forward Voltage Vs Forward Current 伏安特性曲线

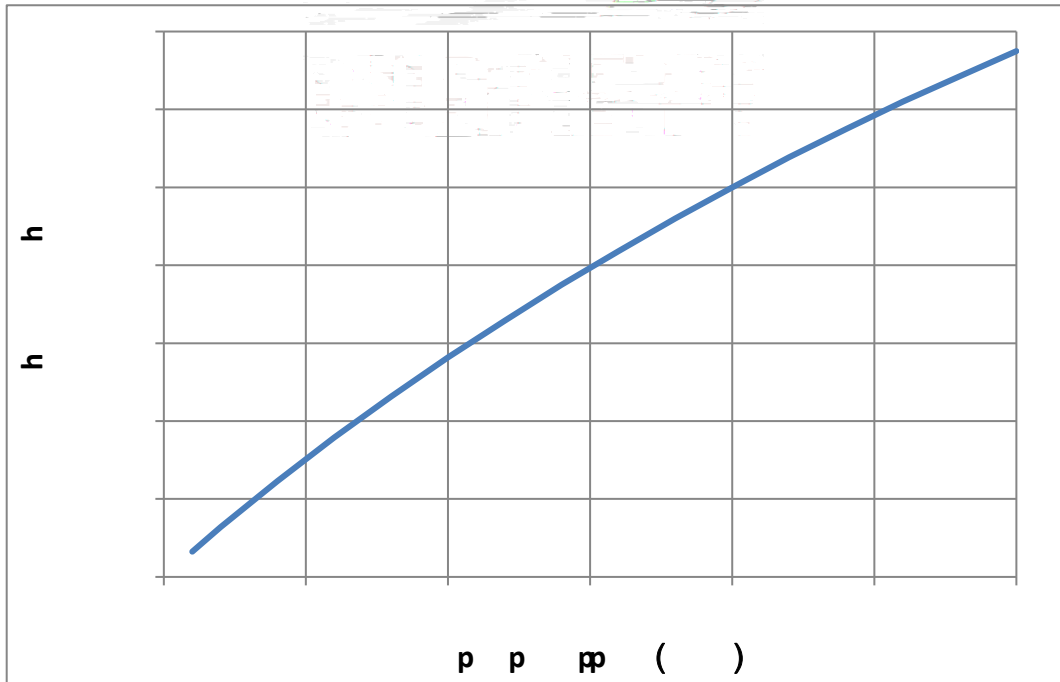

Fig. 1-8 Forward Current Vs Relative Intensity 相对光强与正向电流特性曲线

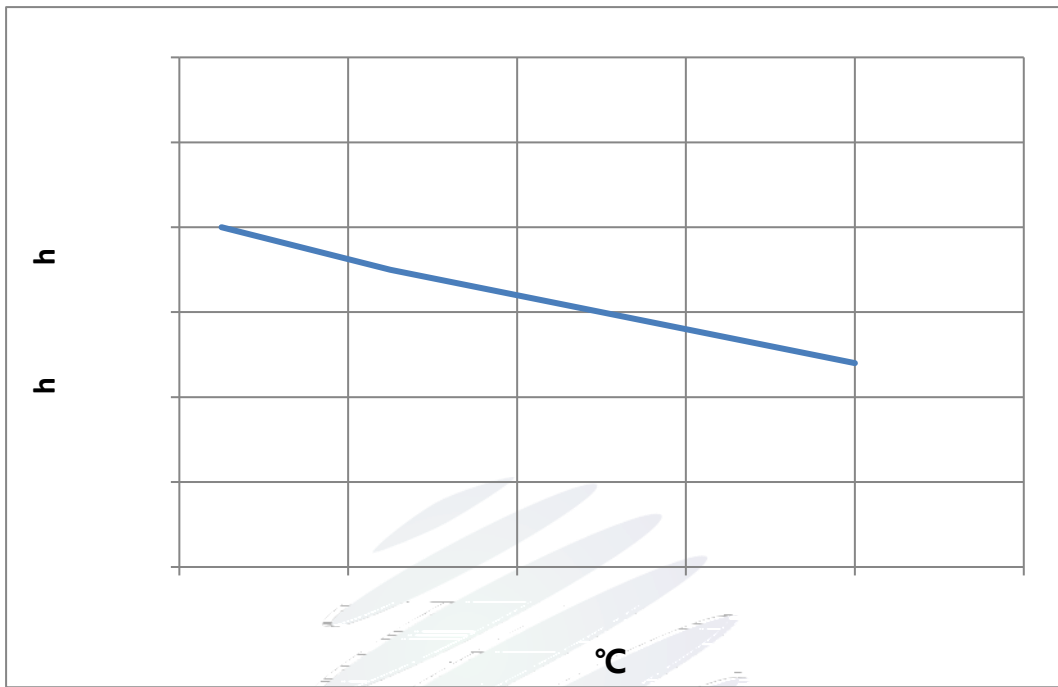

Fig. 1-9 Solder Temperature Vs Relative Intensity 管脚温度与相对光强特性曲线

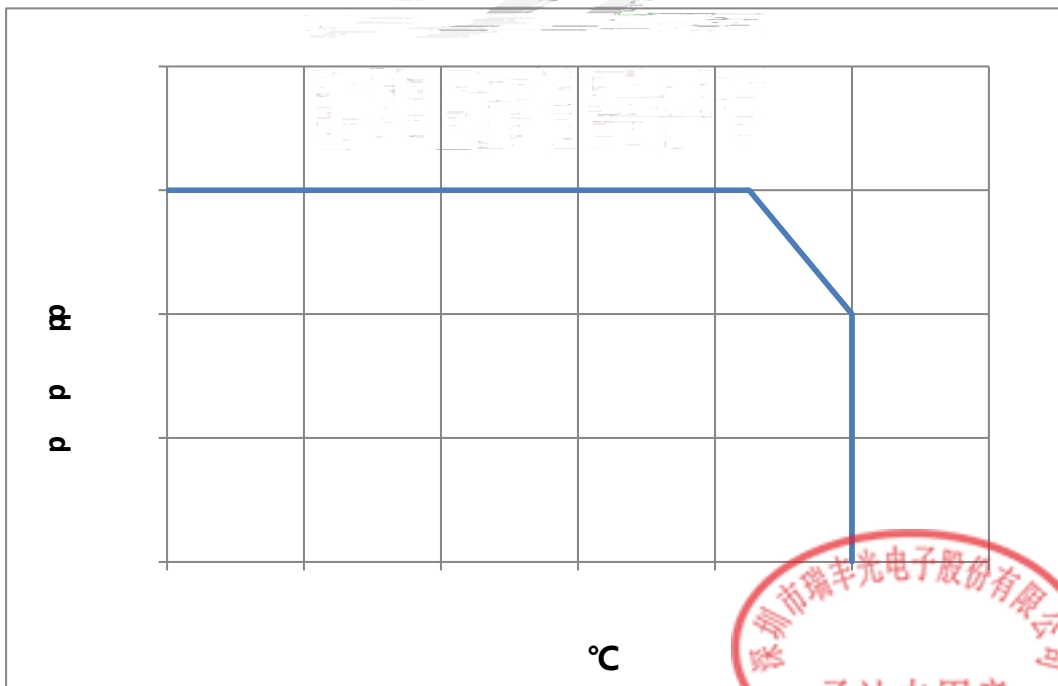

Fig. 1-10 Solder Temperature Vs Forward Current 管脚温度与正向电流特性曲线



Fig. 1-11 Forward Voltage Vs Solder Temperature 电压与管脚温度特性曲线

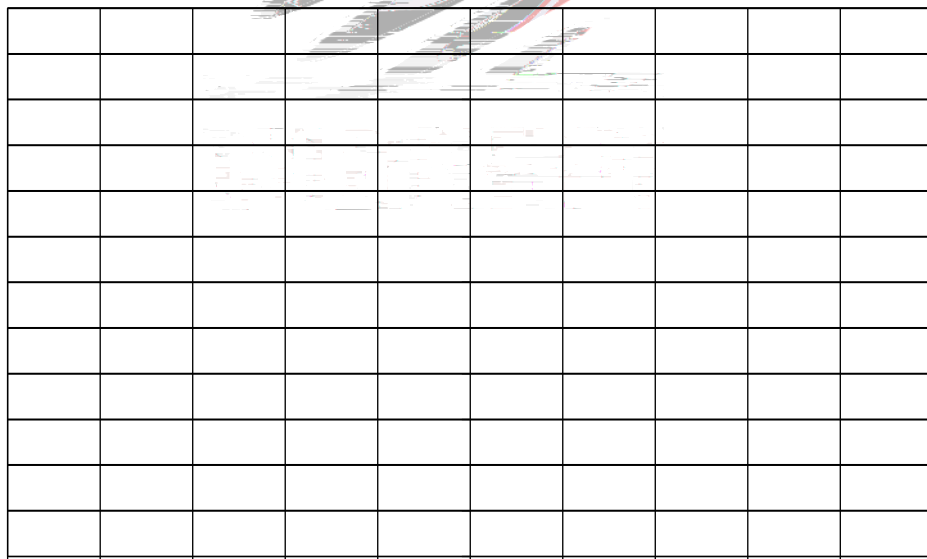

Fig. 1-12 Radiation diagram 辐射特性曲线

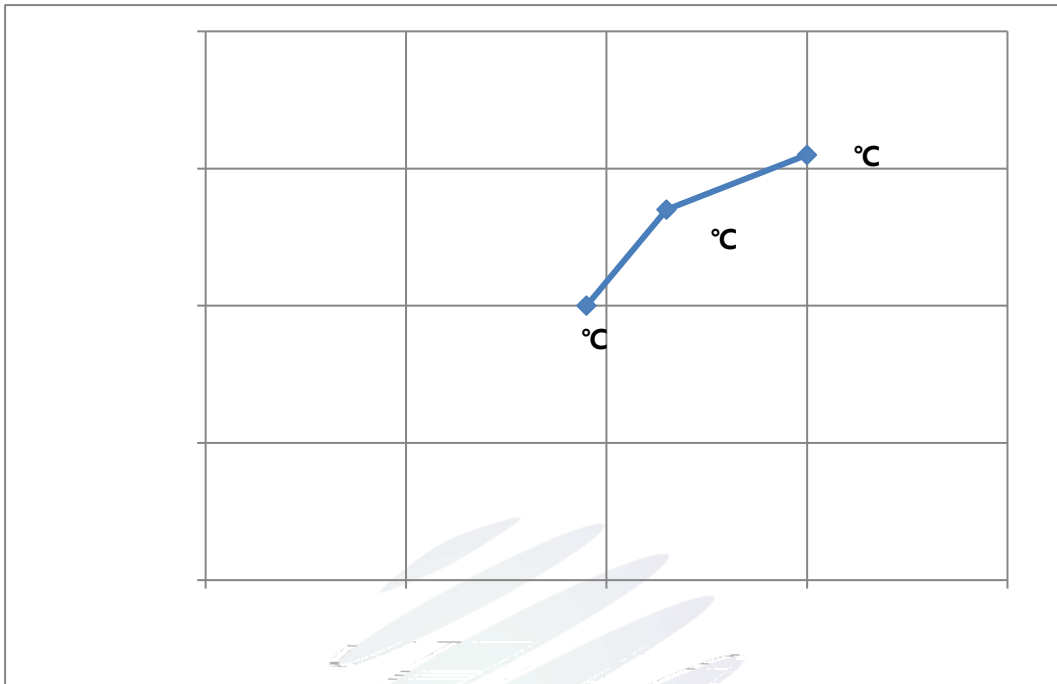

Fig. 1-13 Chromaticity Coordinate Vs Solder Temperature色坐标与管脚温度特性曲线

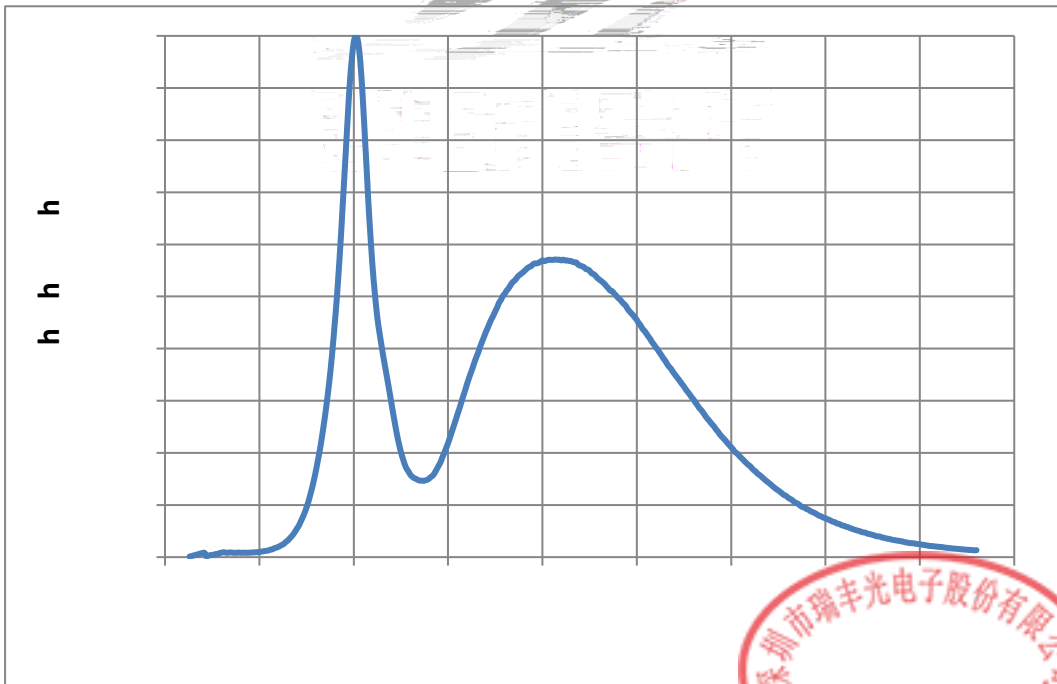

Fig. 1-14 Spectrum Distribution光谱分布特性曲线



2. Packaging 产品包装

2.1 Packaging Specification 包装规格

Package:3000pcs/reel.包装每卷。

2.1.1 Carrier Tape Dimension 载带尺寸

)

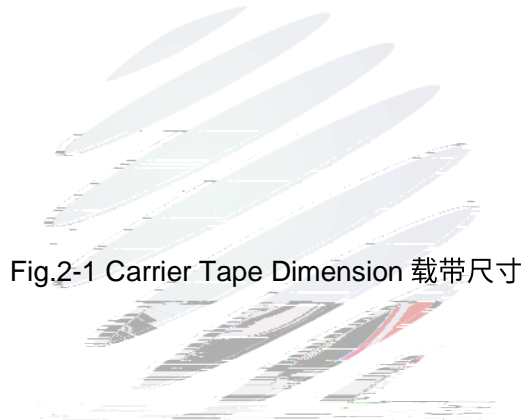
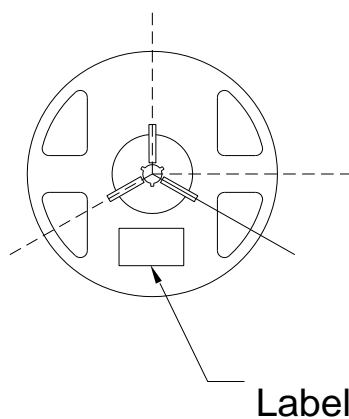

Fig.2-1 Carrier Tape Dimension 载带尺寸

2.1.2 Reel Dimension 卷盘尺寸



Label

Fig.2-2 Reel Dimension 卷盘尺寸

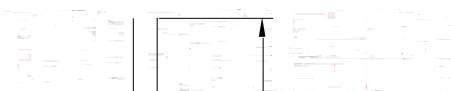

Table 2-1 Reel Dimension 卷盘尺寸

| | |
|---|-------------|
| A | 8.0±0.1mm |
| B | 178.0±1.0mm |
| C | 60.0±1.0mm |
| D | 13.0±0.5mm |

Notes 备注:

The tolerances unless mentioned ±0.1mm. Unit : mm注：未注公差为±0.1毫米，尺寸单位：毫米。



2.1.3 Label Form Specification 标签规格

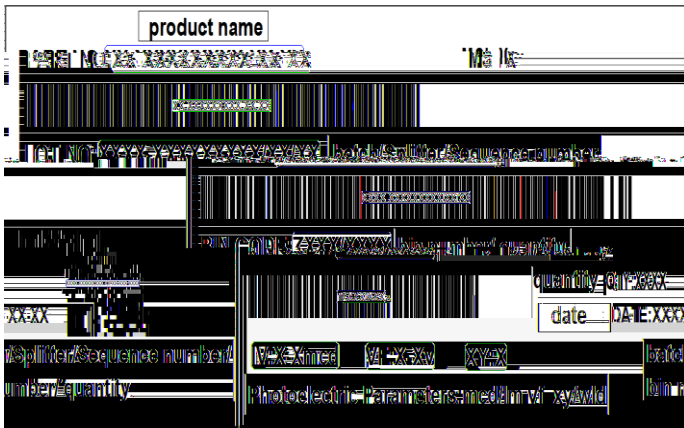

Fig. 2-3 Label Form Specification 标签规格

Table 2-2 Specification 规格

| | |
|----------------|-------------------------|
| PART NO. | Part Number 品名 |
| SPEC NO. | Spec Number 规格 |
| LOT NO. | Lot Number 批次号 |
| BIN CODE | Bin Code 参数代码 |
| IV | Luminous Intensity 发光强度 |
| XY | Chromaticity Bin 色区 |
| V _F | Forward Voltage 正向电压 |
| WLD | Wavelength 波长代码 |
| QTY | Packing Quantity 数量 |
| DATE | Made Date 生产日期 |

2.2 Moisture Resistant Packing 防潮包装

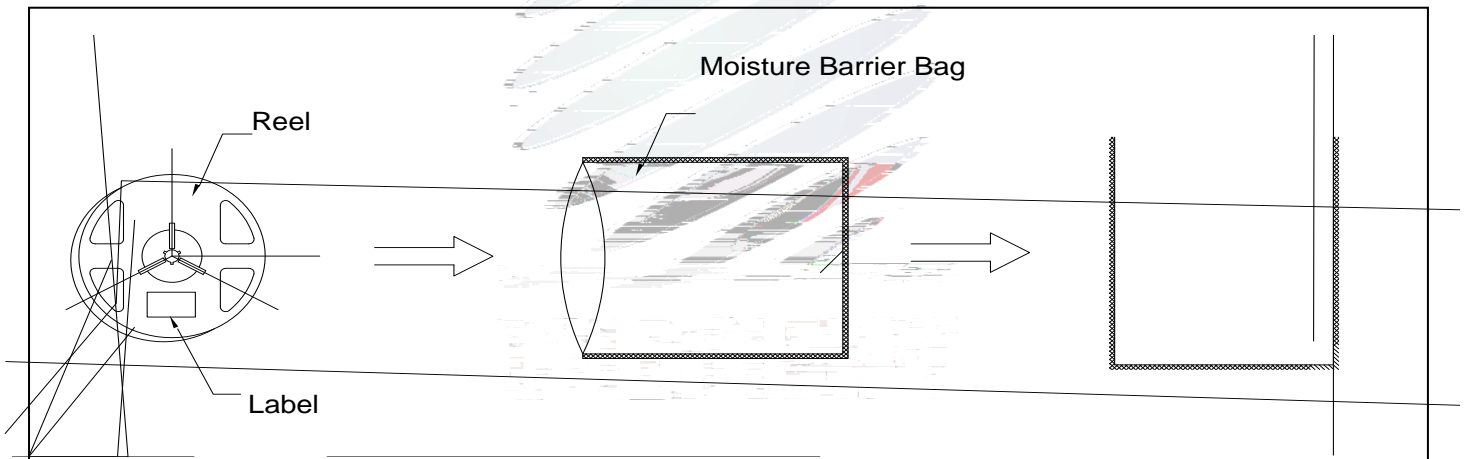

Fig.2-4 Moisture Resistant Packing 防潮包装

2.3 Cardboard Box 包装纸箱

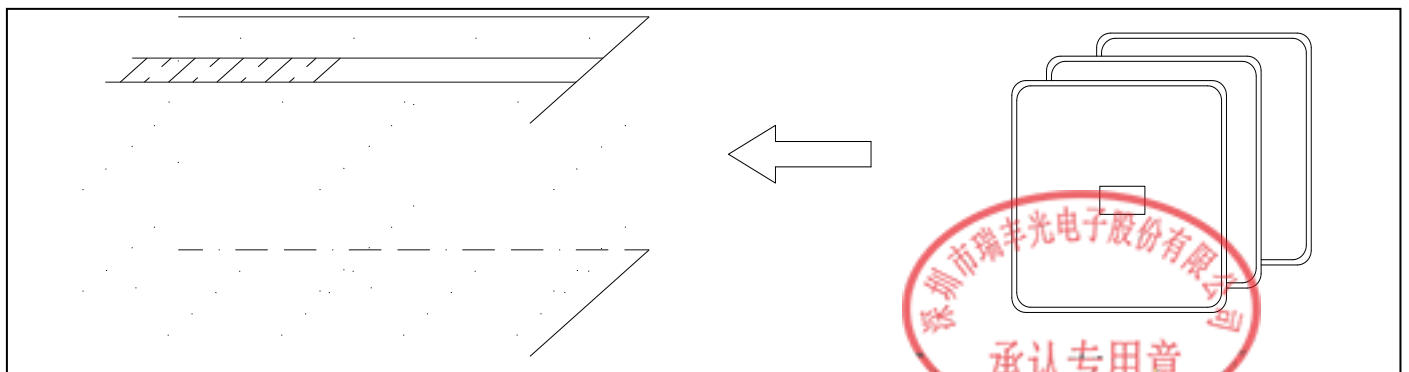

Fig.2-5 Cardboard Box 包装纸箱

2.4 Reliability Test Items And Conditions 信赖性测试项目及条件

Table 2-3 Reliability Test Items And Conditions 信赖性测试项目及条件

| Test Items 项目 | Ref.Standard 参考标准 | Test Condition 测试条件 | Time 时间 | Quantity 数量 | Ac/Re 接收/拒收 |
|--|------------------------|-------------------------------|------------|----------------|----------------|
| Reflow 回流焊 | JESD22-B106 | Temp:260°Cmax T=10 sec | 2times | 20pcs. | 0/1 |
| MSL2 2 | JESD22-A113 | 85°C/ 60%R | 168 hrs. | 20pcs. | 0/1 |
| Thermal Shock | JEITAED-4701 300307 | -40 15min , + 125 15min | 1000 cycle | 20pcs. | 0/1 |
| Life Test | JESD22-A108 | Ta=105 IF=20mA | 1000hrs. | 20pcs. | 0/1 |
| High Temperature High Humidity Life Test | JESD22-A101 | 85 / 85%RH IF=20mA | 1000hrs. | 20pcs. | 0/1 |



2.5 Criteria For Judging Damage 失效判定标准

Table 2-4 Criteria For Judging Damage 失效判定标准

| Test Items 项目 | Symbol 符号 | Test Condition 测试条件 | Criteria For Judgement 判定标准 | |
|----------------------------|--------------|------------------------|--------------------------------|-----------------------------|
| | | | Min. 最小 | Max. 最大 |
| Forward Voltage 正向电压 | V_F | $I_F=20\text{mA}$ | - | $\text{U.S.L}^*)\times 1.1$ |
| Reverse Current 反向电流 | I_R | $V_R = 5\text{V}$ | - | $\text{U.S.L}^*)\times 2.0$ |
| Luminous Intensity 发光强度 | I_V | $I_F=20\text{mA}$ | $\text{L.S.L}^*)\times 0.7$ | - |

Notes 备注:

1.U.S.L: Upper standard level 规格上限 L.S.L: Lower standard level 规格下限

2.The above reliability tests is based on the verification of a single/strip LED of Refond's existing experimental Platform, the reliability experiment was taken under good heat dissipation conditions. When customers applies The LED to the series and parallel circuit, should take consideration of all the factors such as the current, Voltage distribution, heat dissipation and others.以上可靠性测试是基于瑞丰现有实验平台单颗/条 LED 在良好散热条件验证下的结果。客户端将 LED 应用于串、并联线路时，需自行评估电流、电压分配、散热等问题。

3.The technical information shown in the data sheets is limited to the typical characteristics and circuit examples of the referenced products. It does not constitute the warranting of industrial property nor the granting of any license. 以上技术数据仅为产品的典型值，只作为参考，不作为任何应用条件及应用方式的保证。



3. SMT Reflow Soldering Instructions SMT 回流焊说明

3.1 SMT Reflow Soldering Instructions SMT 回流焊说明

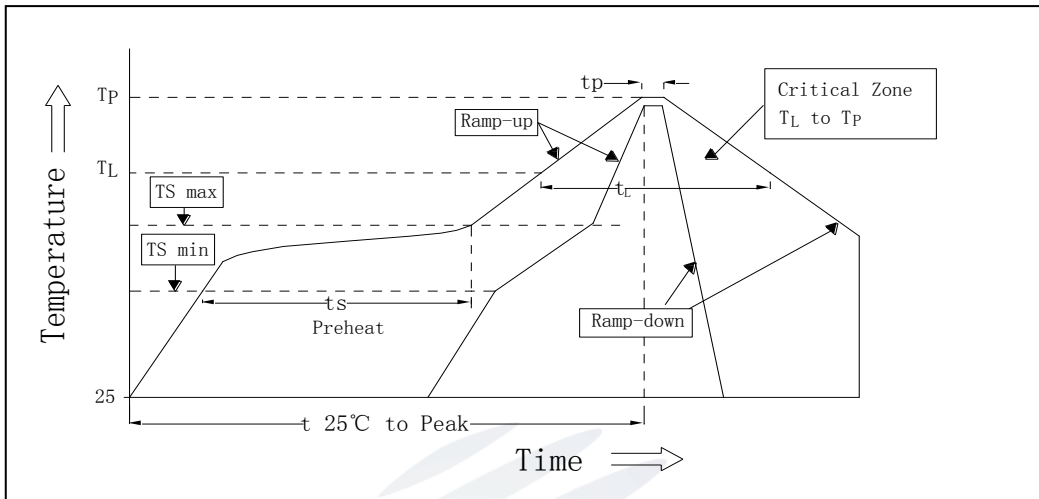
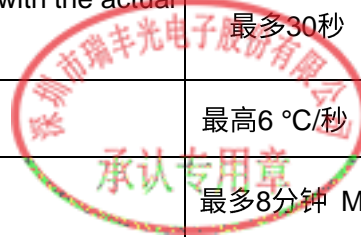

Fig.3-1 SMT Reflow Soldering Instructions SMT 回流焊说明

Table 3-1 Reflow parameters 回流焊参数

| | |
|--|----------------------|
| Average temperature rise speed 平均升温速度 (Tsmax至TP) | 最高3 °C/秒 Max 3 °C/ s |
| Preheating: minimum temperature 预热: 最低温度 (Tsmín) | 150 °C |
| Preheating: Max temperature 预热: 最高温度 (Tsmáx) | 200 °C |
| Preheating: Time 预热: 时间 (Tsmín至Tsmáx) | 60 - 120秒 60s-120s |
| Time limited to maintain high temperature: the temperature 限时维持高温: 温度 (TL) | 217 °C |
| Time limited to maintain high temperature: The Time 限时维持高温: 时间 (tL) | 最多60秒 Max 60s |
| Peak /Classification of temperature: 峰值 / 分类温度 (TP) | 260 °C |
| Time limit classification of peak temperature time 限时峰值分类温度: 时间 (tp) | 最多10秒 Max 10s |
| 与实际峰值温度 (TP) 相差 5 °C 以内的保持时间 Hold time within 5 °C with the actual peak temperature (TP) | 最多30秒 Max 30s |
| 降温速度 Cooling speed | 最高6 °C/秒 Max 6 °C/ s |
| 25 °C 升至峰值温度所需时间 Needed time from 25 °C to Tp | 最多8分钟 Max 8 minutes |



Notes 备注:

(1)Reflow soldering should not be done more than twice. If more than 24 hours between the two soldering,LED will be damaged. 回流焊次数不可以超过两次，两次回流焊的时间间隔如果超过24小时，LED可能由于吸湿而损坏。

(2)When soldering , do not put stress on the LEDs during heating.焊接时，不要在材料受热时用力压胶体表面。

3.1.1 Soldering Iron 烙铁焊接

(1) When do soldering by hand, keep the temperature of iron below less 300°C less than 3 seconds 当手工焊接时,烙铁的温度必须小于300°C，时间不可超过3秒。

(2) Soldering by hand should be done only one time.手工焊接只可焊接一次。

3.1.2 Repairing 修补

Repairing should not be done after the LEDs have been soldered. When repairing is unavoidable,a double-head soldering iron should be used (as below figure). It should be confirmed in advance whether the characteristics of LEDs will or not be damaged by repairing.

LED流焊后不可再进行手工烙铁修复,如必须手工烙铁修复,应事先确认烙铁温度,烙铁温度不可超过LED本身的特性。

3.1.3 Cautions 注意事项

(1) The encapsulated material of the LEDs is silicone. Therefore the LEDs have a soft surface on the top of package. The pressure to the top surface will be impacted on the reliability of the LEDs. Precautions should be taken to avoid the strong pressure on the encapsulated part. So when use the picking up nozzle, the pressure on the silicone resin should be proper. LED封装胶为硅胶，表面较软，用力按压胶体表面会影响LED可靠性，因此应有预防措施避免在按压器件，当使用吸嘴时，胶体表面的压力应是恰当的。

(2) Components should not be mounted on warped (non coplanar) portion of PCB. After soldering, do not warp the circuit board.LED 灯珠不要焊接在弯曲的 PCB 板上，焊接之后，也不要弯折线路板。

(3) Do not apply mechanical force or excess vibration during the cooling process to normal temperature after soldering. Do not rapidly cool device after soldering.回流焊之后冷却过程中，不要对材料施加外力，也不要震动，回流焊后，不要采用激剧冷却的方式。



4. Handling Precautions 产品使用注意事项

4.1 Handling Precautions 产品使用注意事项

(1) LED operating environment and sulfur element composition cannot be over 100PPM in the LED mating usage material. This is provided for informational purposes only and is not a warranty or endorsement. LED 工作 LED 适配的材料中硫元素及化合物成份不可超过 100PPM.这只是一个建议，不作任何品质担保。

(2) In o

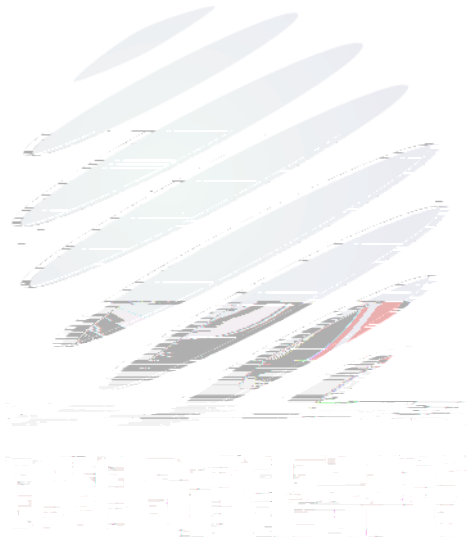

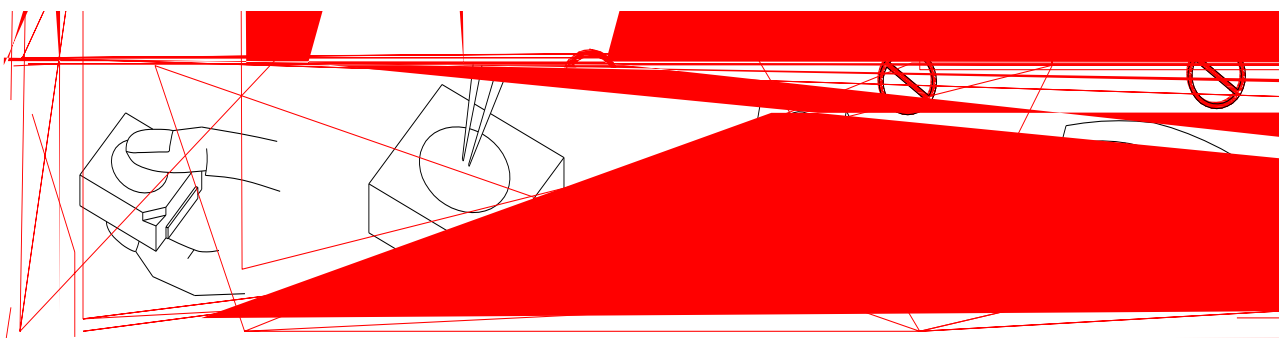

Fig 4-1 Handling Precautions 产品使用注意事项

(5) In designing a circuit, the current through each LED can not exceed the absolute maximum rating specified for each LED. In the meanwhile, resistors for protection should be applied, otherwise slight voltage shift will cause big current change, burn out may happen. The driving circuit must be designed to allow forward voltage only when it is ON or OFF. If the reverse voltage is applied to LED, migration can be generated resulting in LED damage. 设计电路时，通过 LED 的电流不能超过规定的最大值。同时，还需使用保护电阻。否则，微小的电压变化将会引起较大电流变化，可能导致产品损毁。电路设计必须保证只有在开启或者关闭的时候出现正向电压的变化，不要施加反压，否则会损坏 LED。

(6) Thermal Design is paramount importance because heat generation may result in the Characteristics decline, such as brightness decreased, Color change and so on. Please consider the heat generation of the LEDs when making the system design. LED 容易因为自身的发热和环境的温度改变而改变，温度升高会降低 LED 发光效率，影响发光颜色，所以在设计时应充分考虑散热问题。

(7) Compared to standard encapsulants, silicone is generally softer, and the surface is more likely to attract dust, requiring special care during processing. In cases where a minimal level of dirt and dust particles cannot be guaranteed, a suitable cleaning solution must be applied to the surface after the soldering of components. Refond suggests using isopropyl alcohol for cleaning. In case other solvents are used, it must be assured that these solvents do not dissolve the package or resin. Ultrasonic cleaning is not recommended. Ultrasonic cleaning may cause damage to the LED. 与其他封装胶相比，硅胶通常较软，表面易吸附脏物，应用时应特别注意。当对产品洁净度要求较高时，回流焊以后需要采用恰当的清洗方式。我们推荐使用异丙醇作清洗剂。如需用到其他清洗剂，必须保证不会破坏封装体。超声清洗可能会对 LED 带来损害，不推荐这种清洗方式。

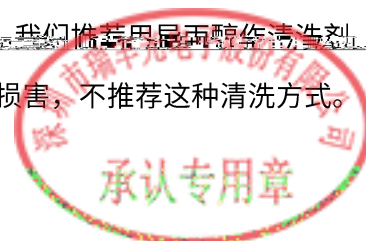
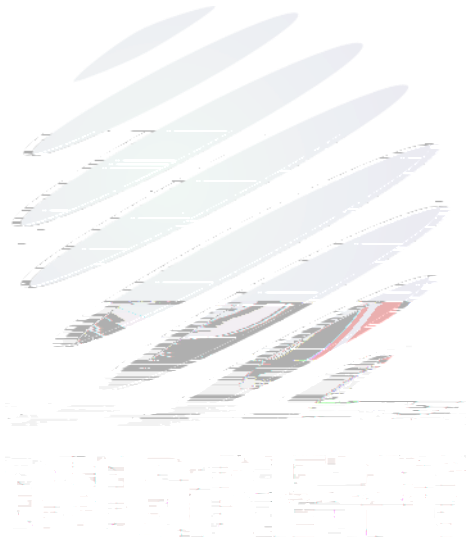

Table 4-1 Storage 储存

| Conditions 种类 | | Temperature 温度 | Humidity 湿度 | Time 时间 |
|------------------|------------------------------------|-------------------|----------------|---|
| Storage 储存 | Before Opening Aluminum Bag 拆包前 | ≤30°C | ≤75% | Within 1 Year From Date 一年内 |
| | After Opening Aluminum Bag 拆包后 | ≤30°C | ≤60% | Recommended for use within 24 hours 建议24小时内使用 |

Baking

烘烤



| Date日期 | Revisor修订者 | Version版本 | Verifier审核 | Remarks备注 |
|------------|----------------------|-----------|-------------------|-----------|
| 2023/02/02 | 陈炜雄 Chen weixiong | E0 | 朱益明 Zhu Yiming | 新发行 |
| | | | | |
| | | | | |
| | | | | |
| | | | | |

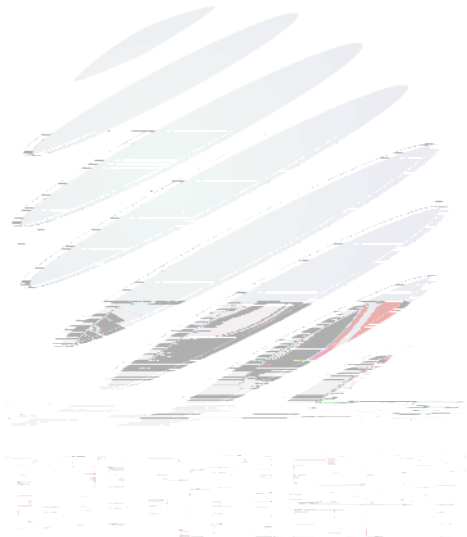

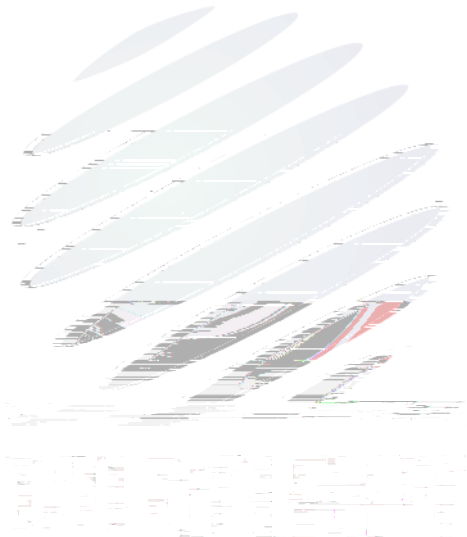

Declare