

1.4

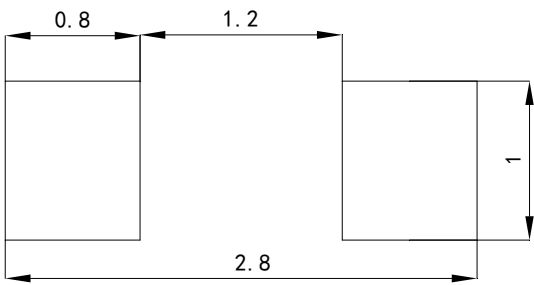

±

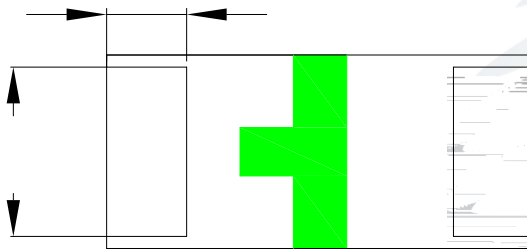
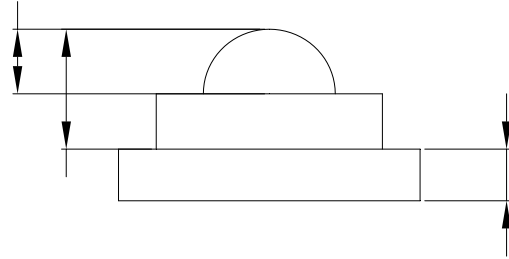
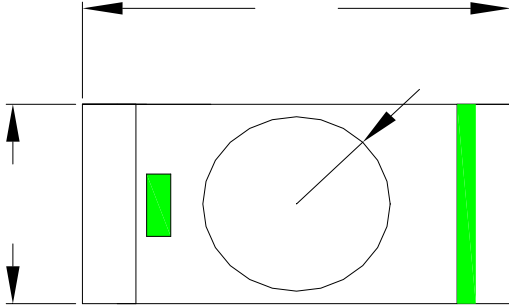
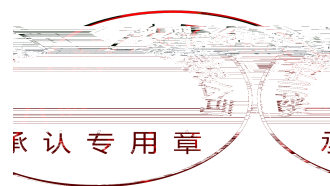

1.5

						μ

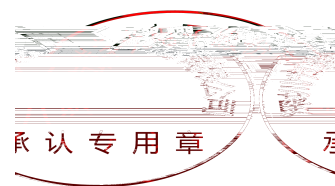

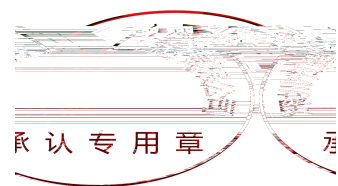

1.

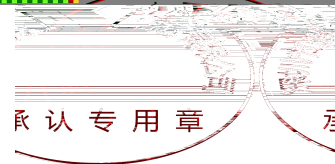
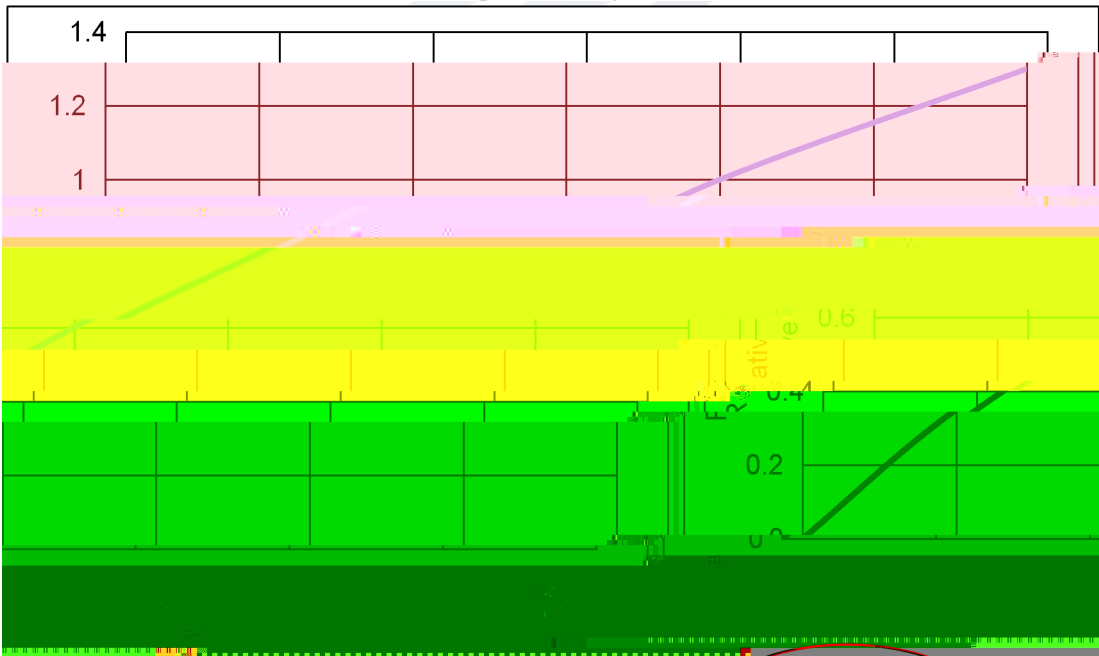
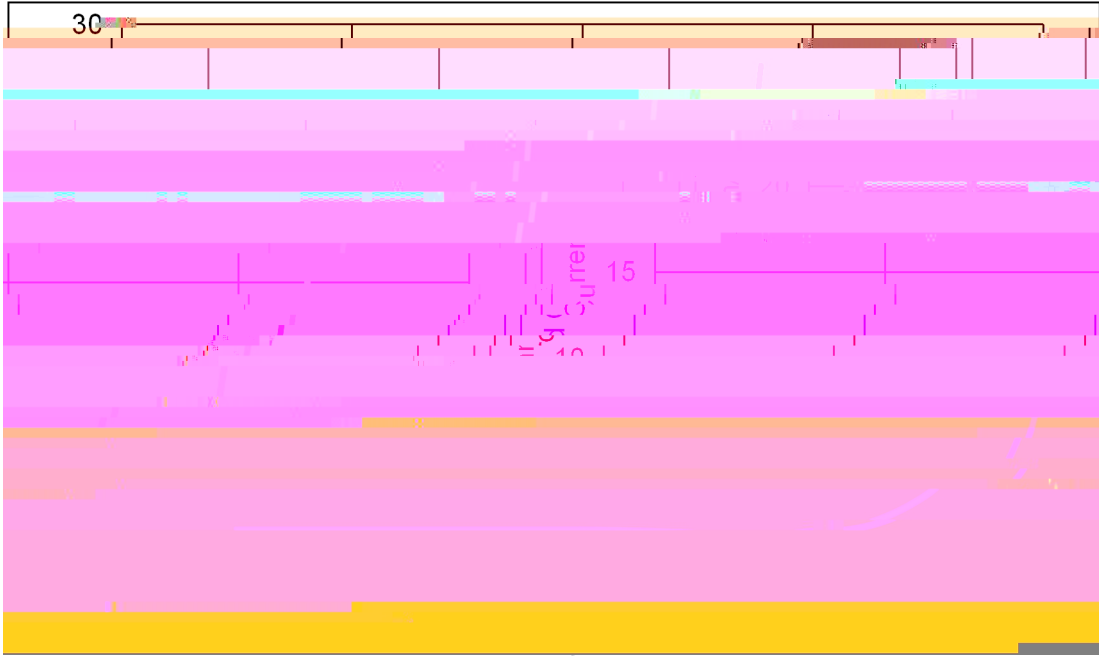

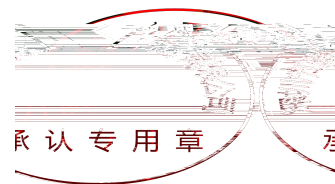
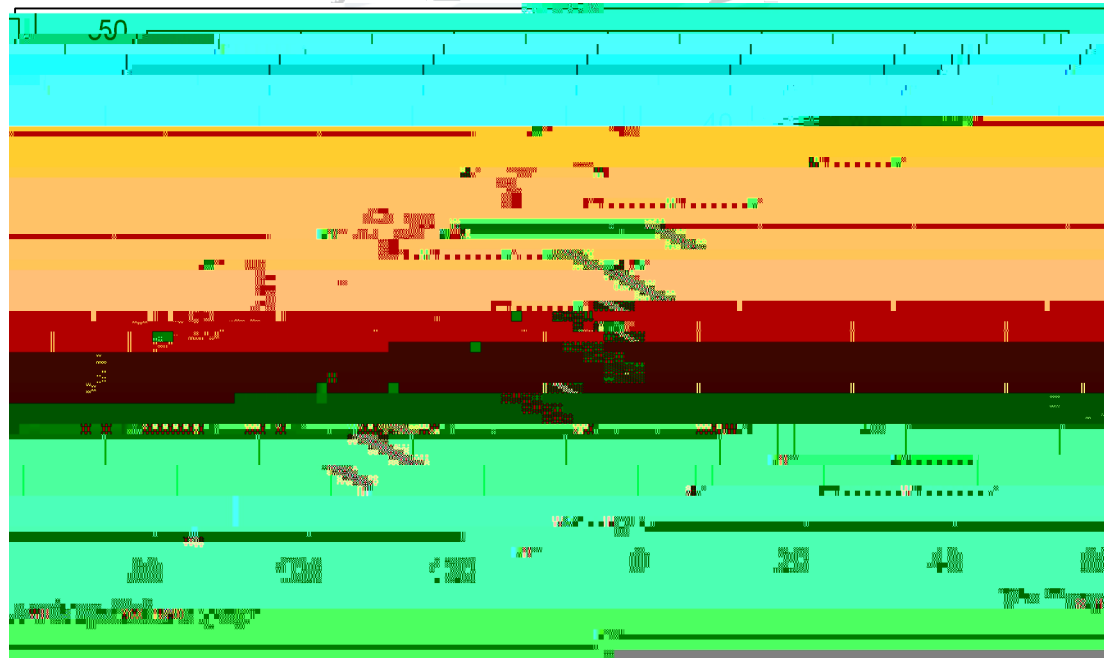
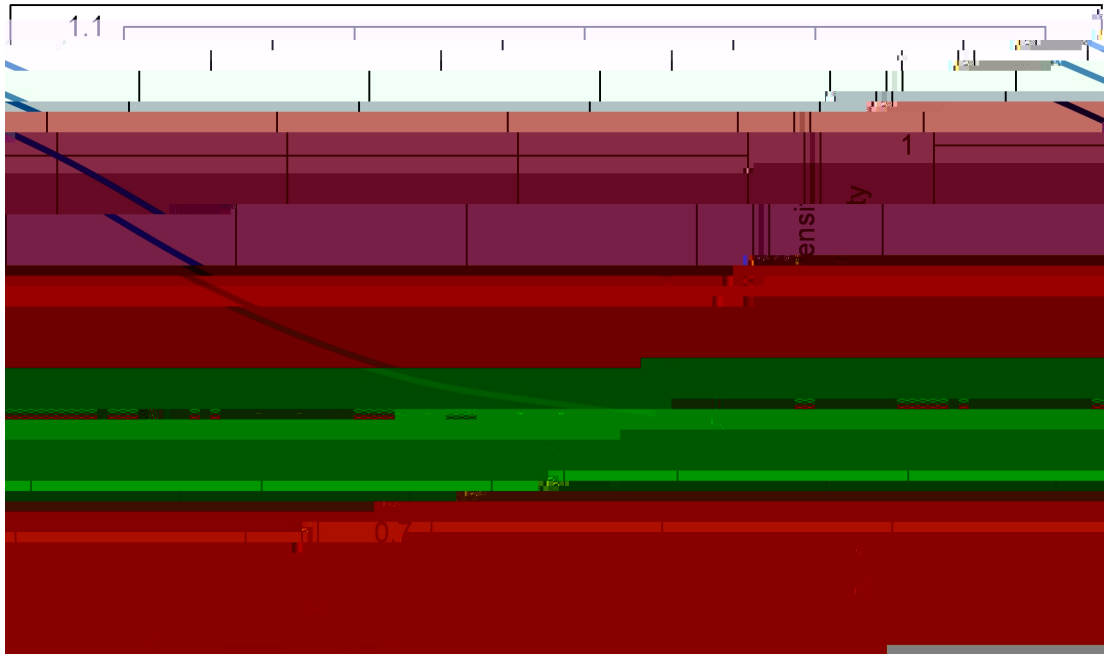

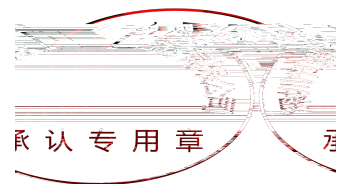
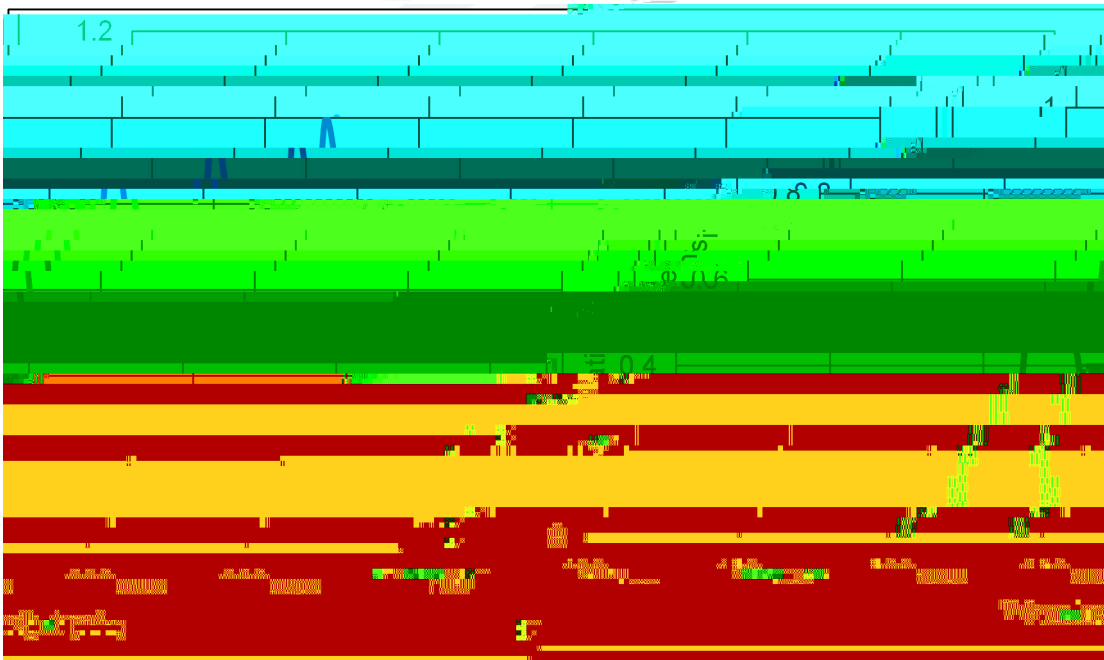
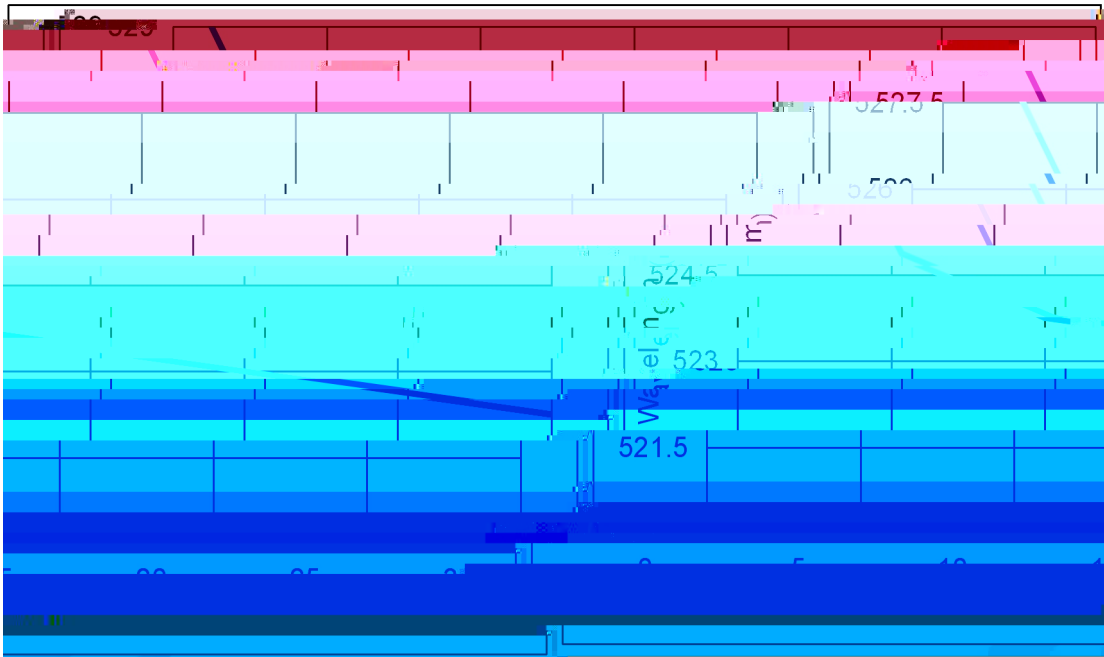

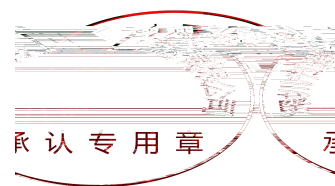
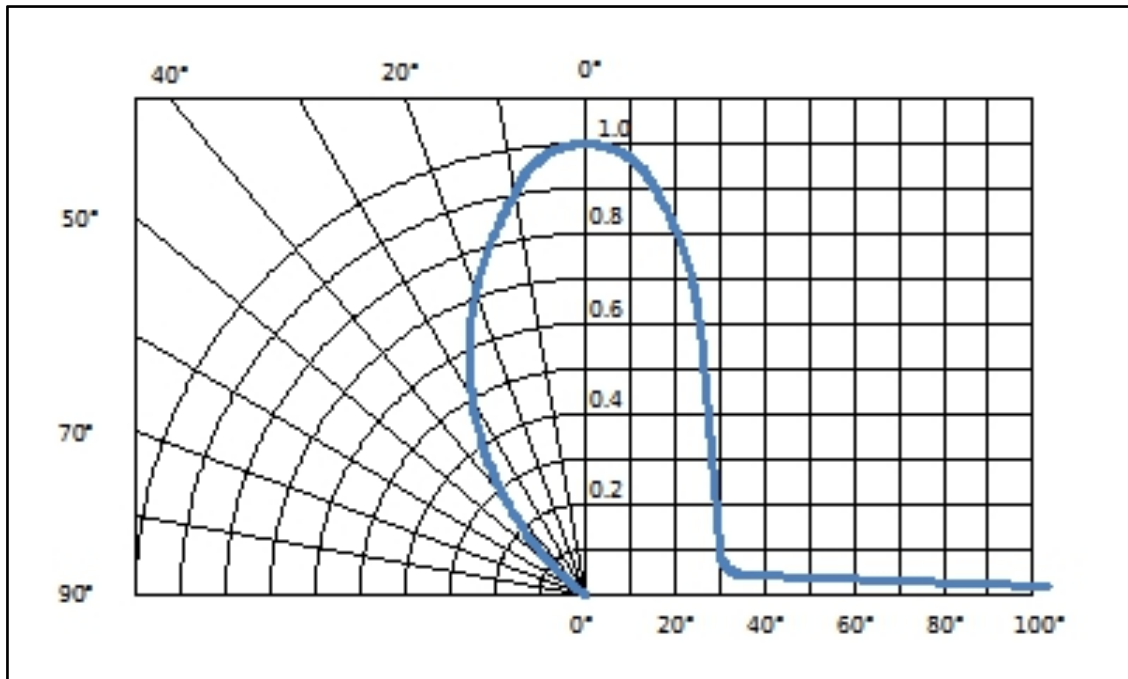

2.

2.1

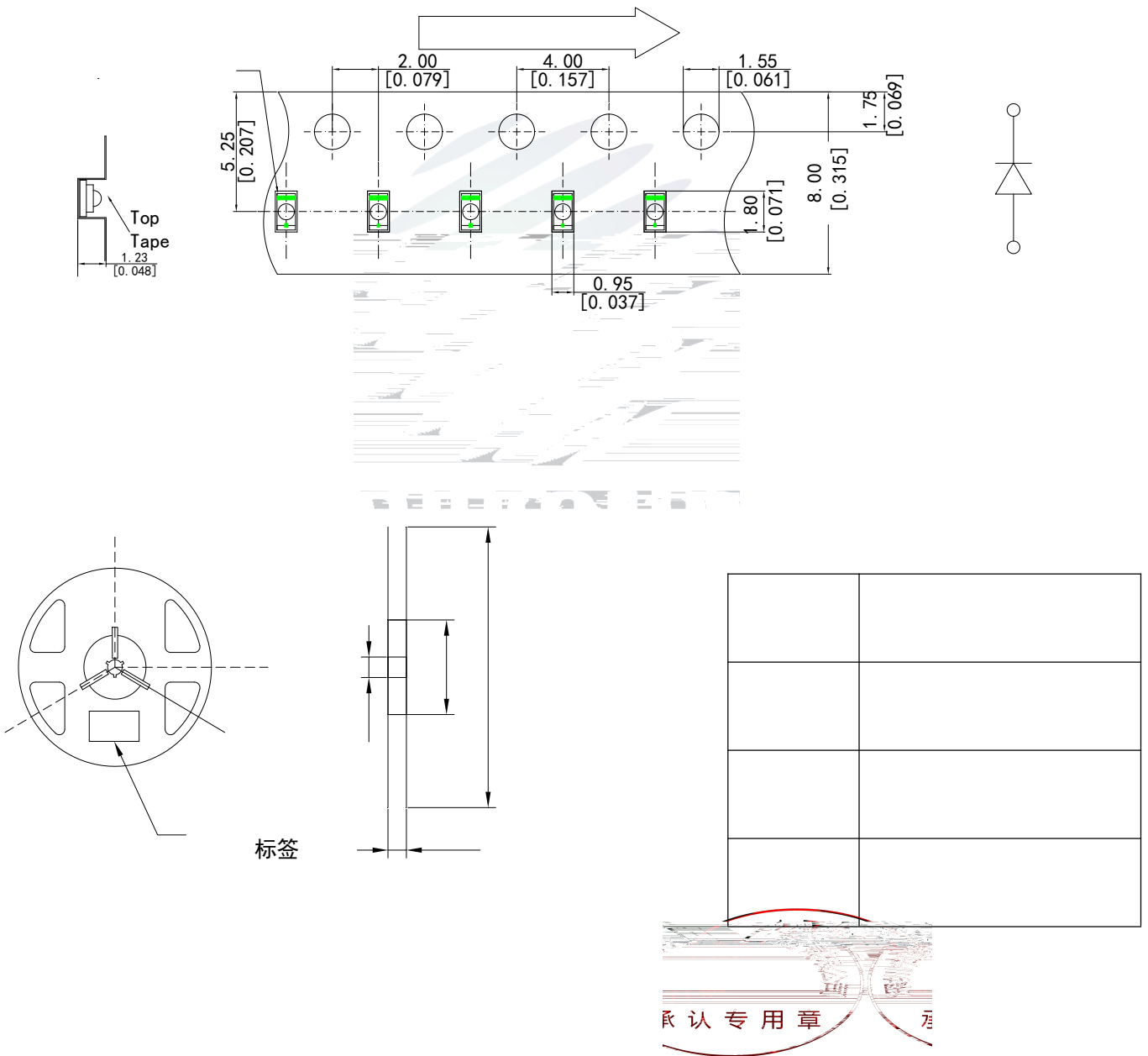



2.2

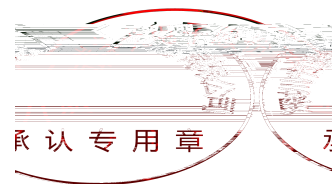
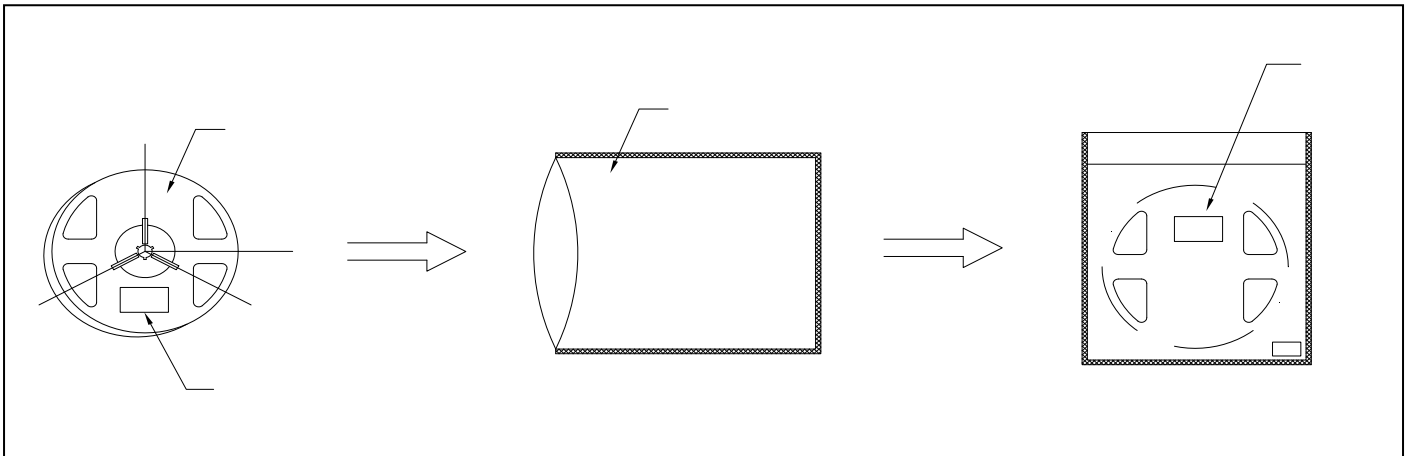

2.3

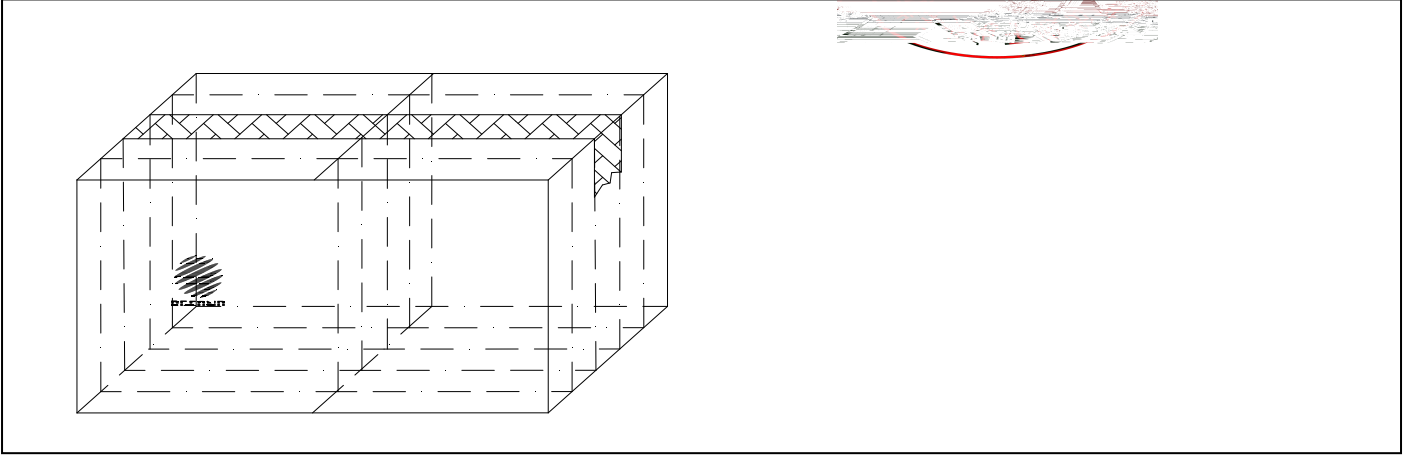
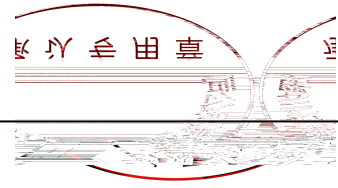

2.4



2.5





4.

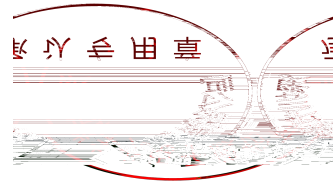

4.1





