

1.

1.1 General Description

1.2

1.3

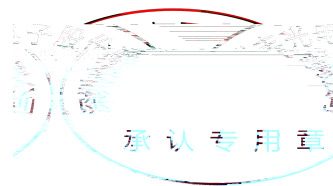

1.4

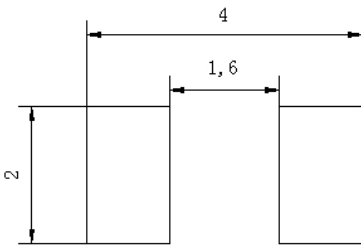
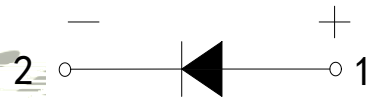
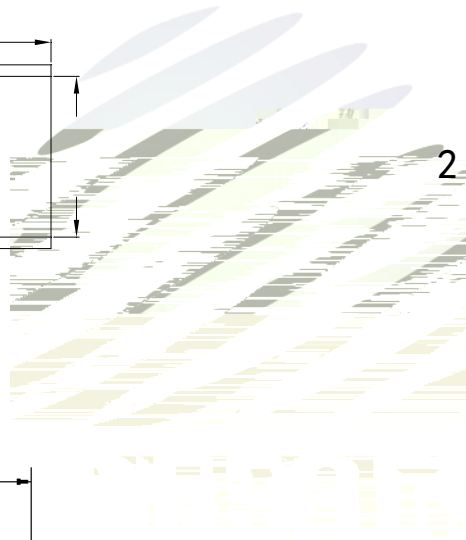
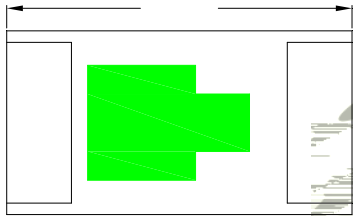
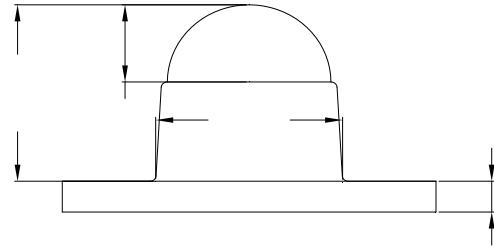
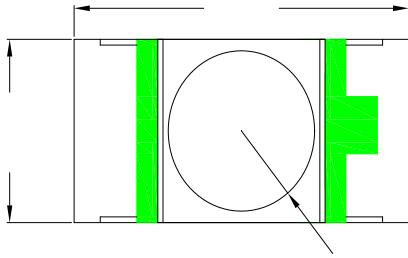

±

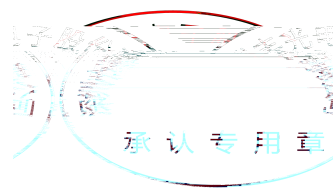

1.5

							μ

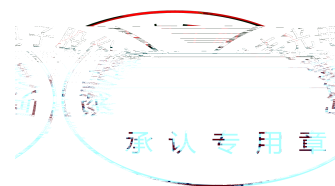

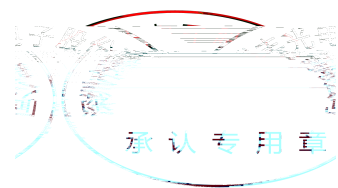
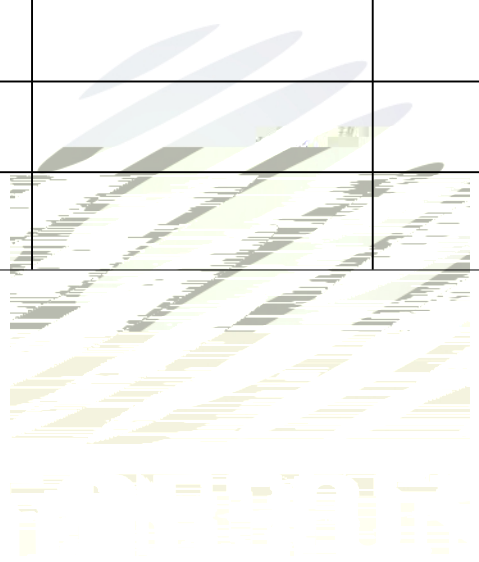

1.

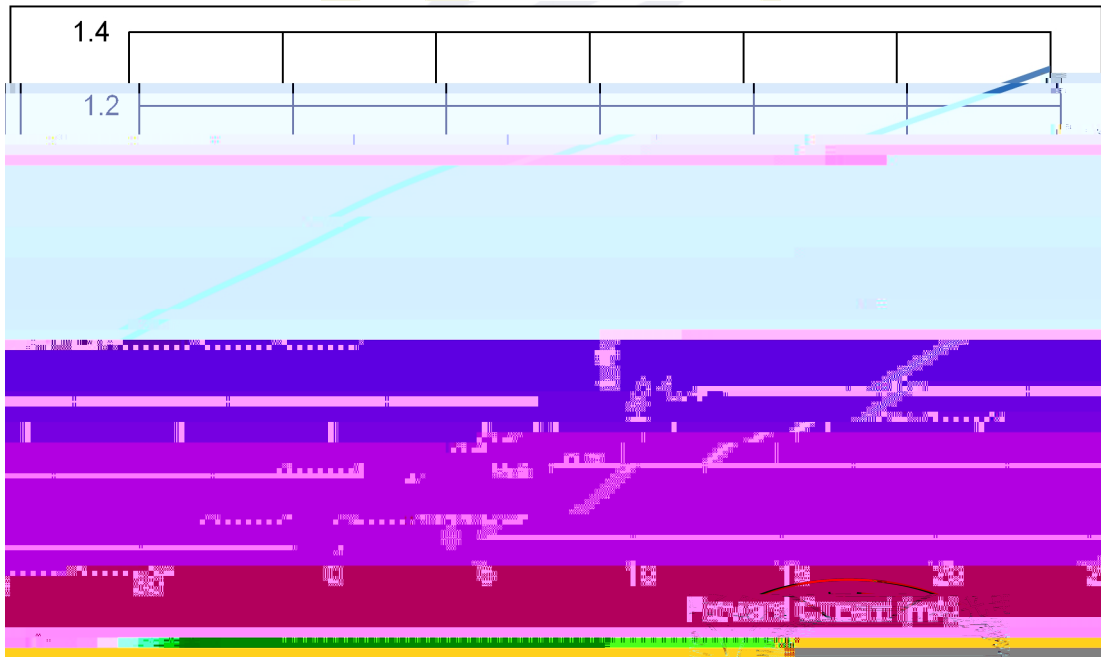
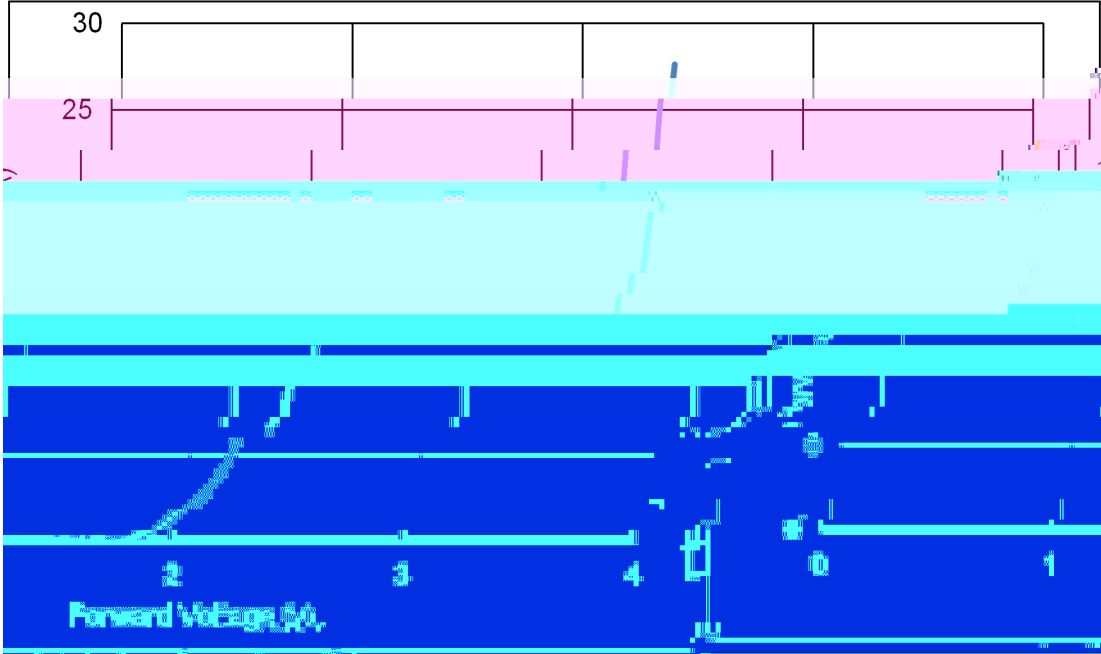

承认专用章

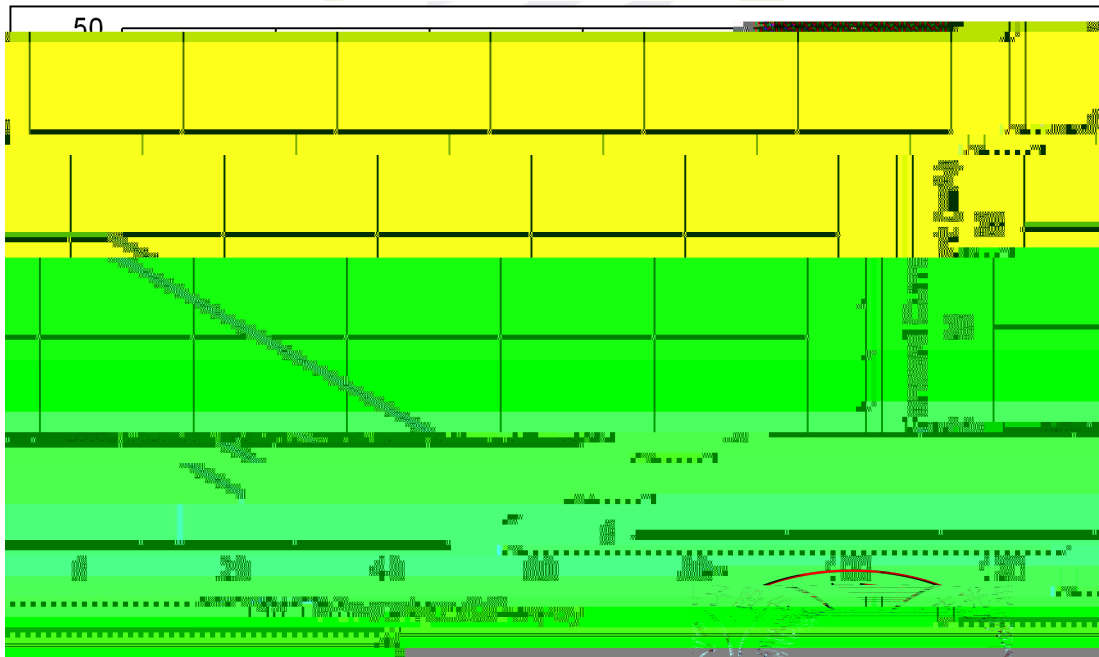
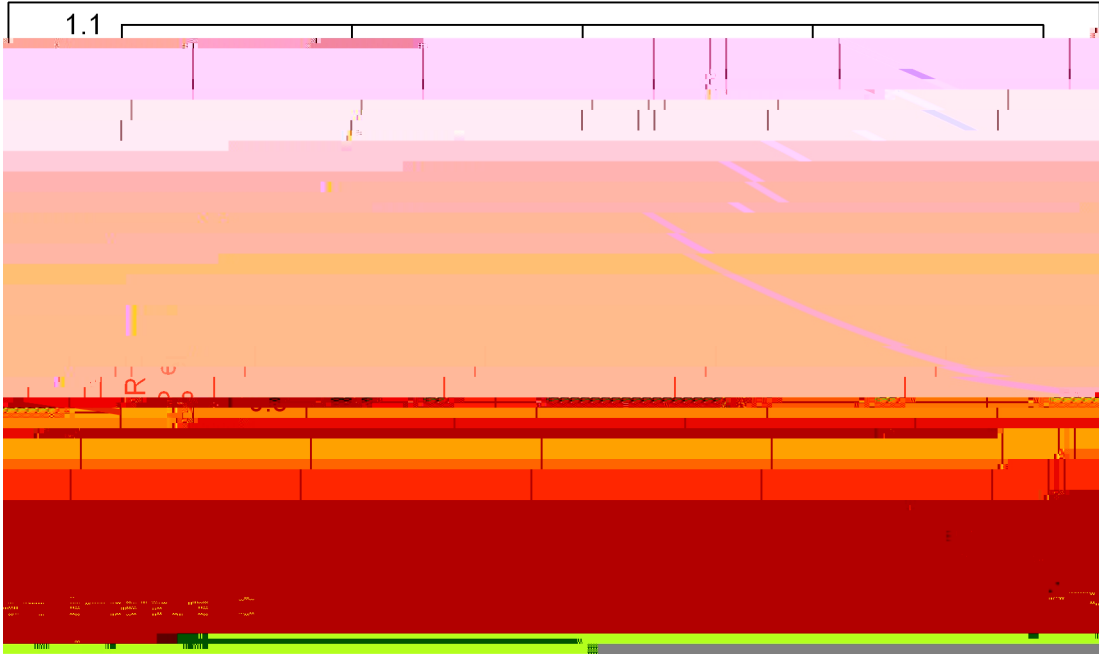

承认专用章

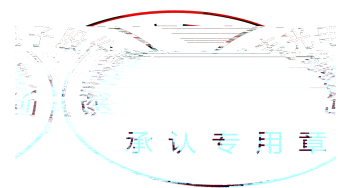
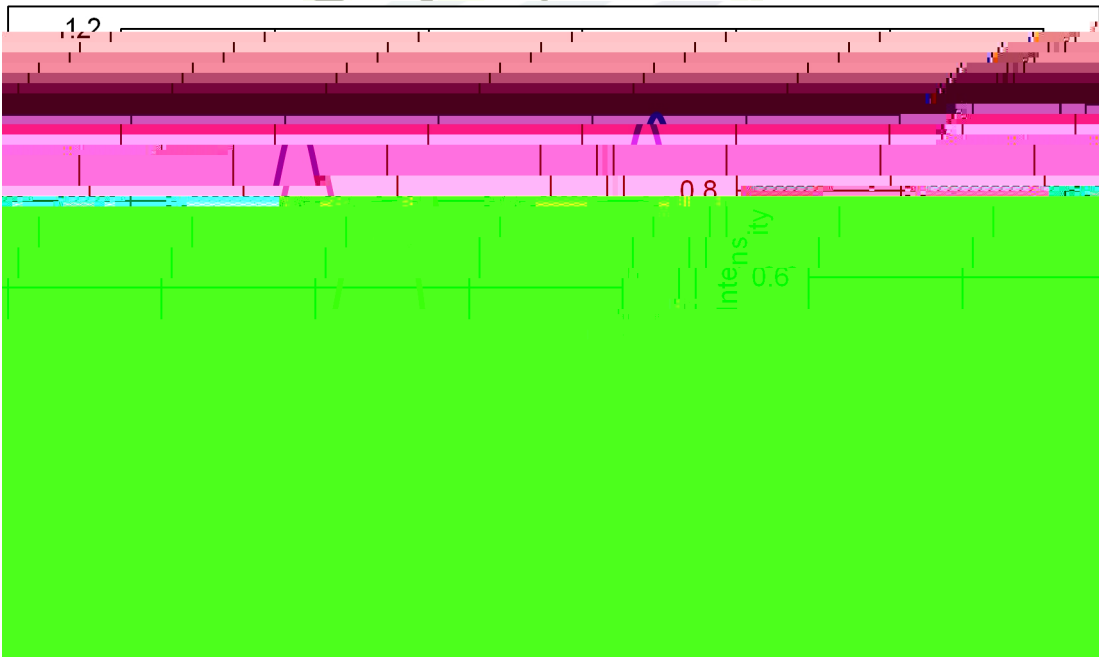
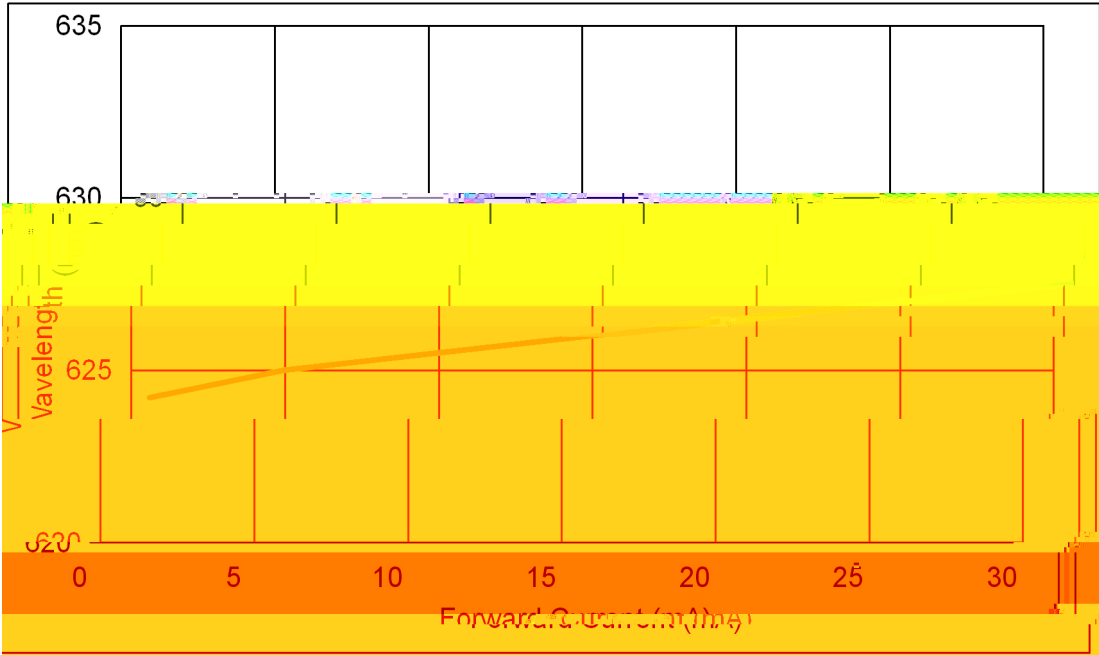

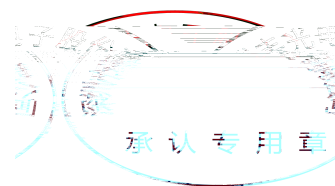
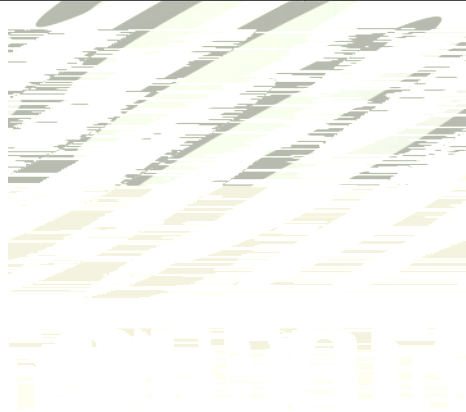
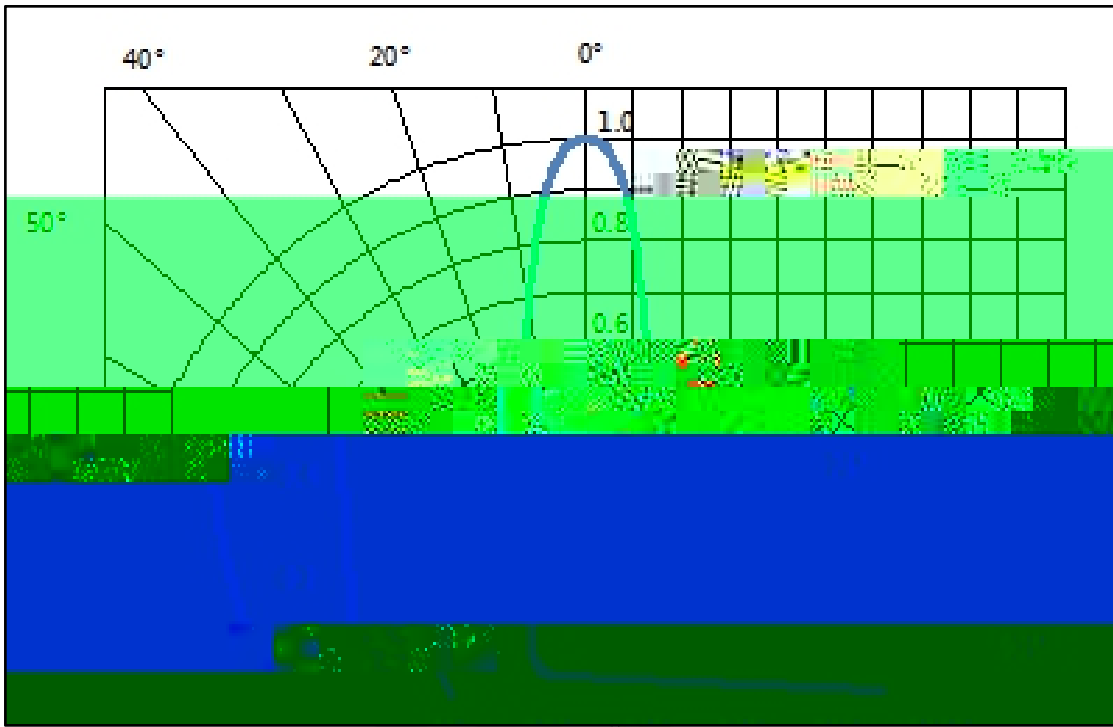

2.

2.1

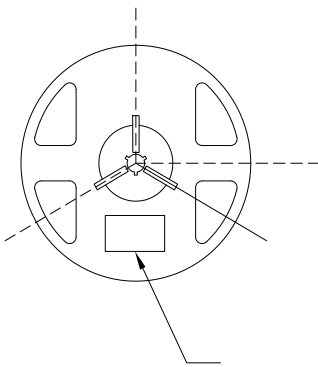
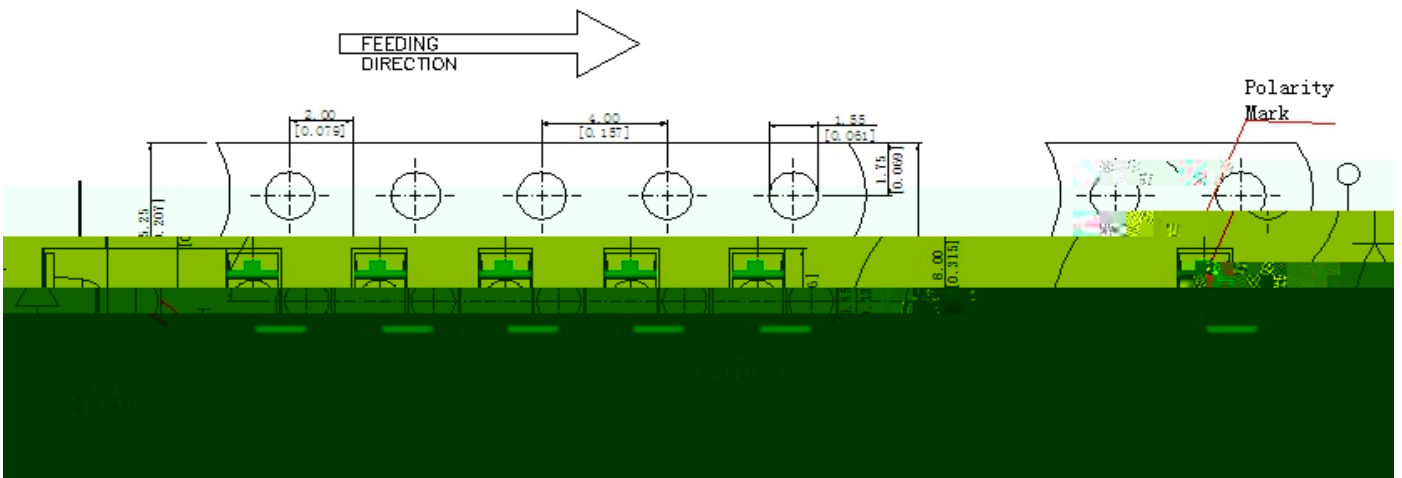

标金

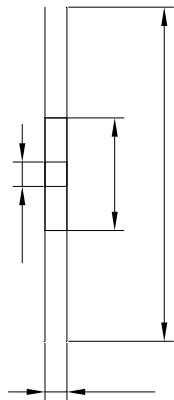

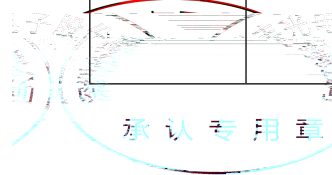





2.2

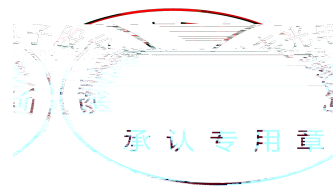
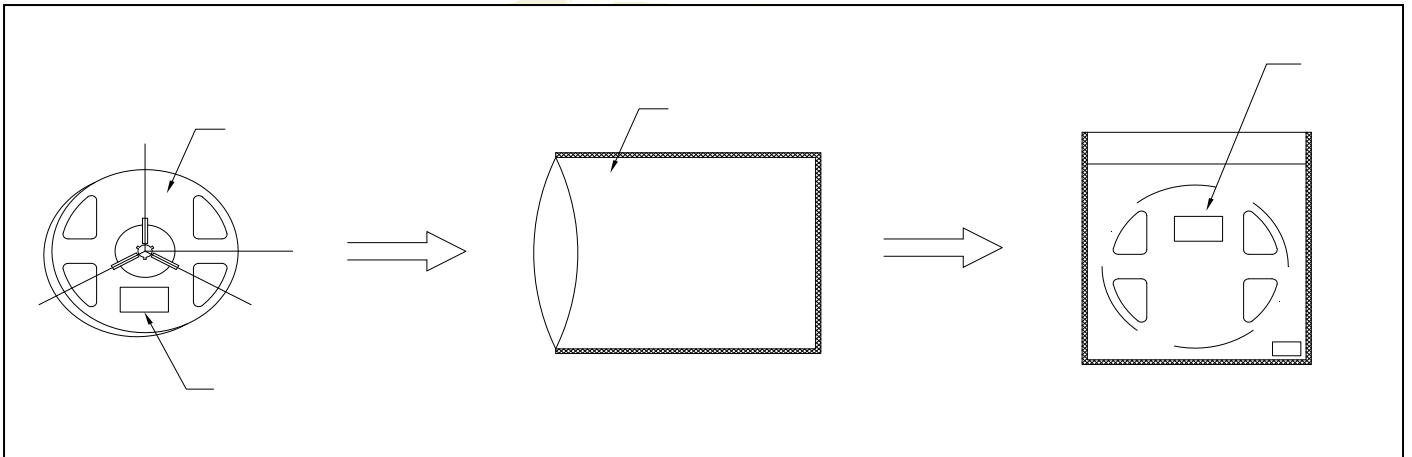

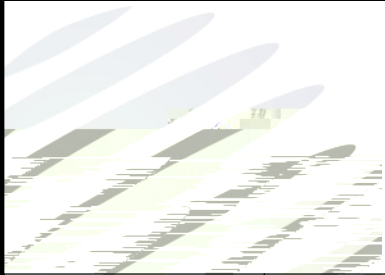
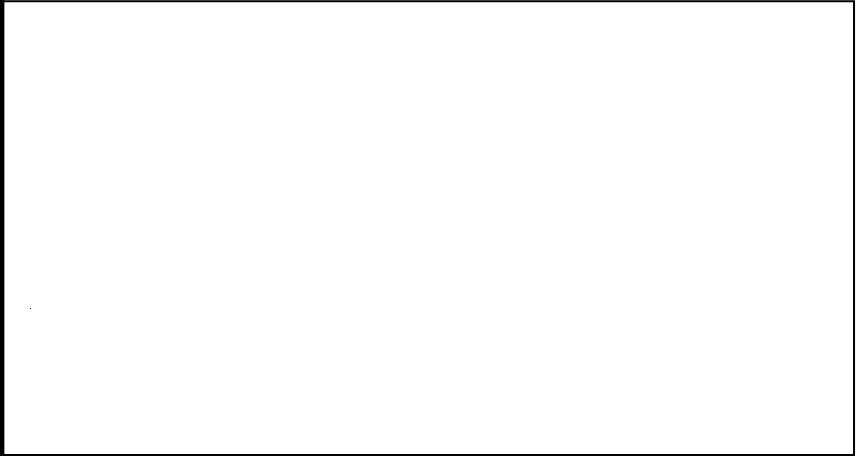

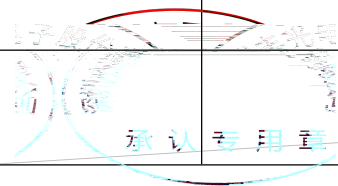

2.5

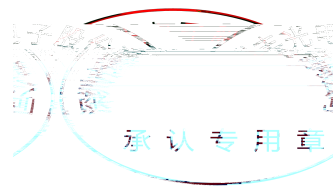
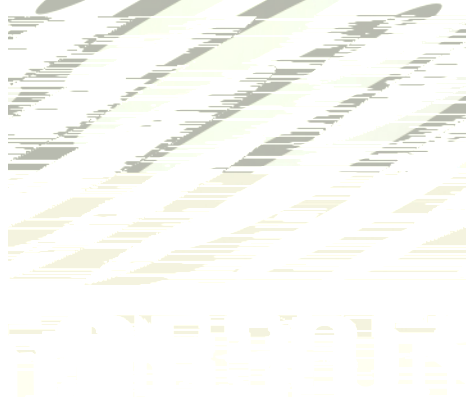

3.1

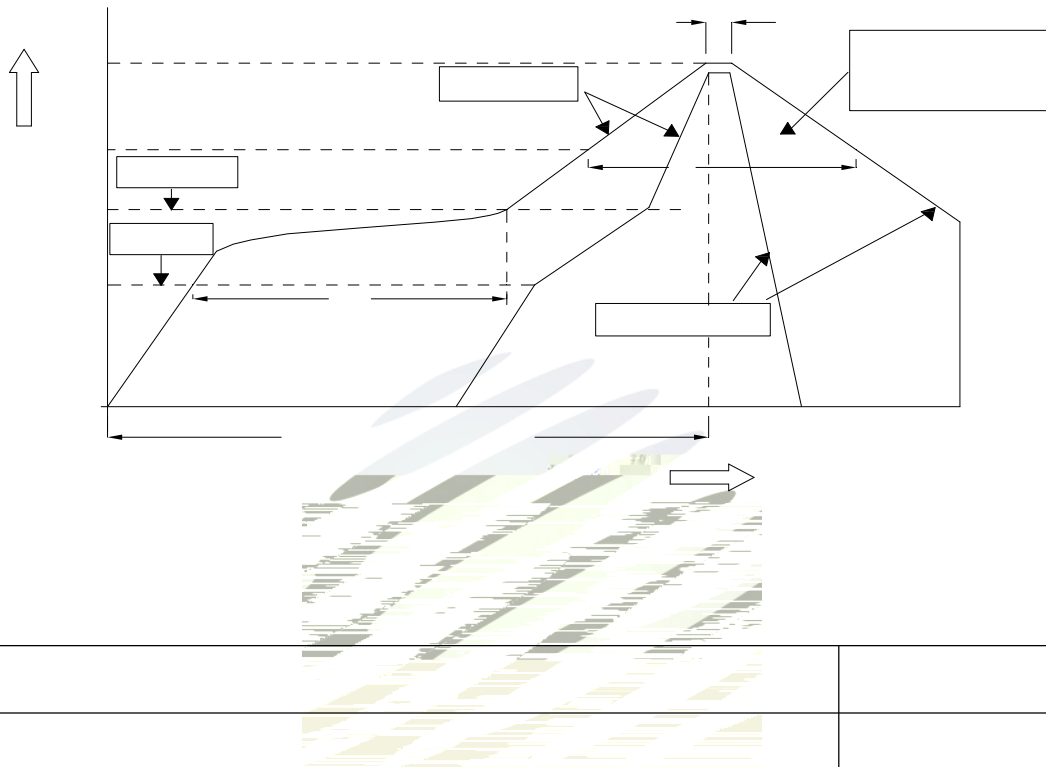

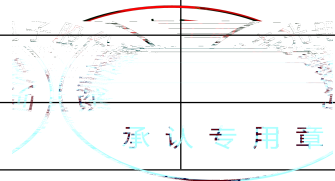

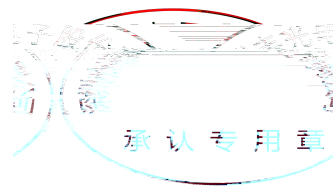

4.

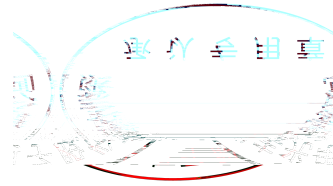

4.1

R U



VR



