

- 1.
- 1.1
- 1.2
- 1.3
- 1.4
- 1.5
- 1.6
- 2.
- 2.1
- 2.2
- 2.3
- 2.4
- 2.5
- 3.
- 3.1
- 4.
- 4.1

- 2.1.1
- 2.1.2
- 2.1.3

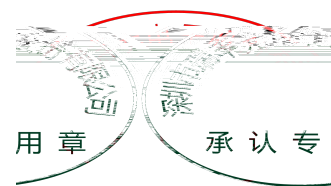

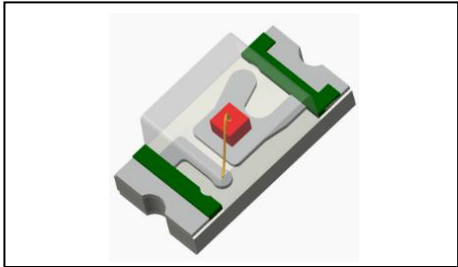

1.6 0.8 0.7

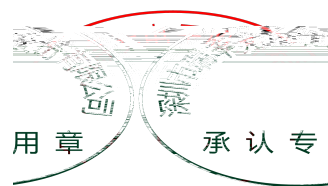
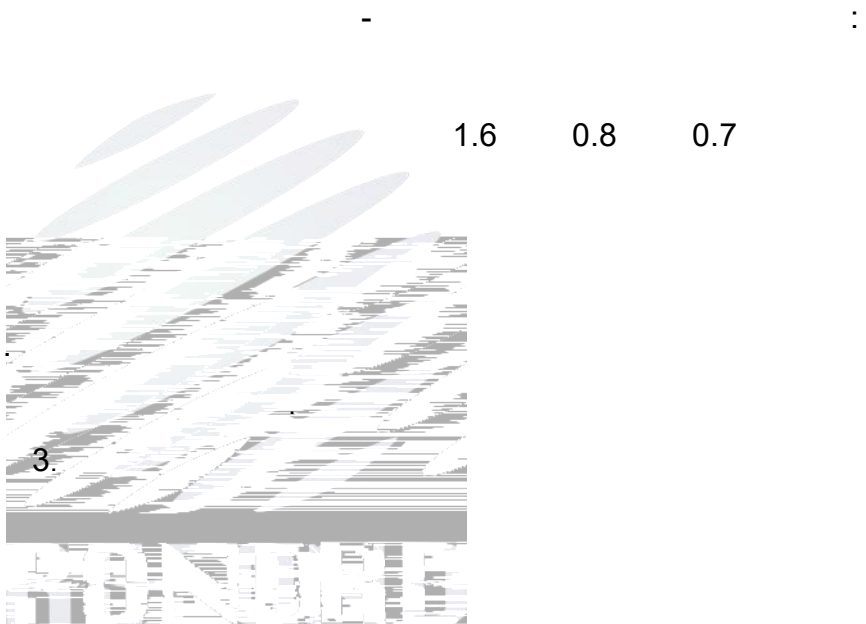

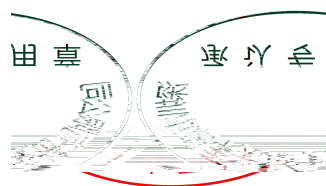

1-1 / =25

				( )		
	=20	△		--	15	--
	=20		1	1.8	--	1.9
			2	1.9	--	2.0
			1	2.0	--	2.1
			2	2.1	--	2.2
			1	2.2	--	2.3
			2	2.3	--	2.4
	=20		20	567.5	--	570.0
			10	570.0	--	572.5
			20	572.5	--	575.0
	=20		00	12	--	18
			00	18	--	28
			00	28	--	43
			00	43	--	65
	=20	2 1/2		--	140	--
	=5			--	--	10 μ
	=20			--	--	450 /

: =5

=5

用章 承认专

1-2

=25

( )

72

30

60

2000

-40 +85

°C

-40

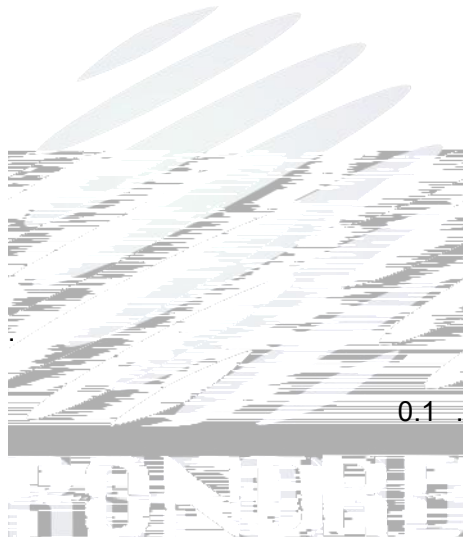

1. 1/10 , 0.1

2.

3.

4.

5.

6.

7.

10%.



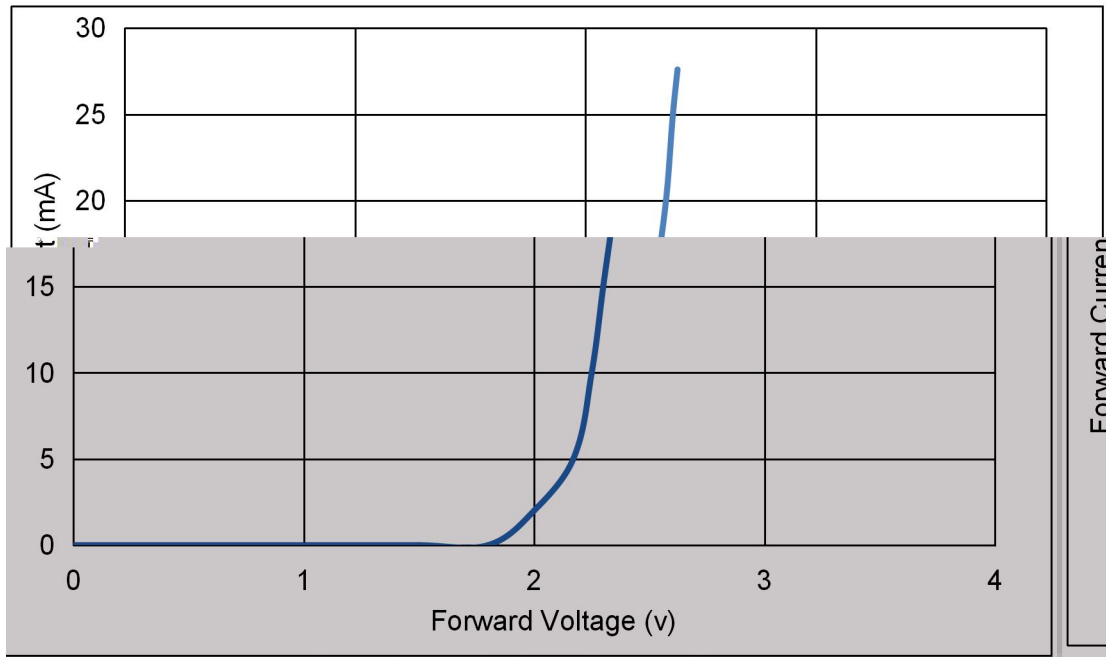

1-6

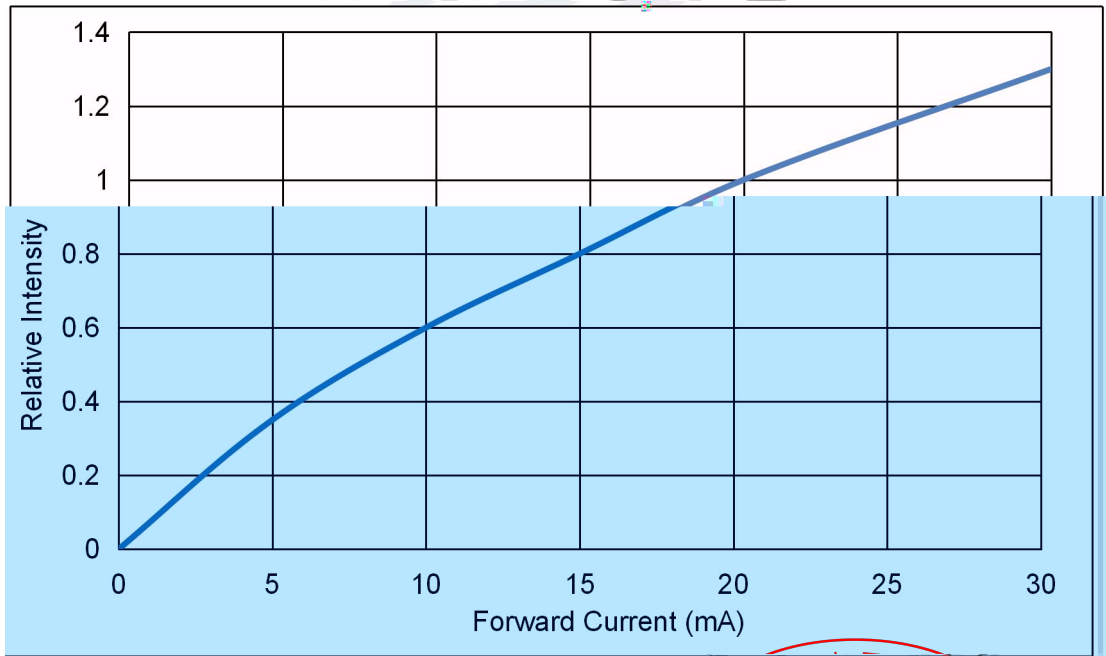

1-7

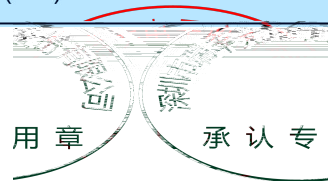

1-8 % /





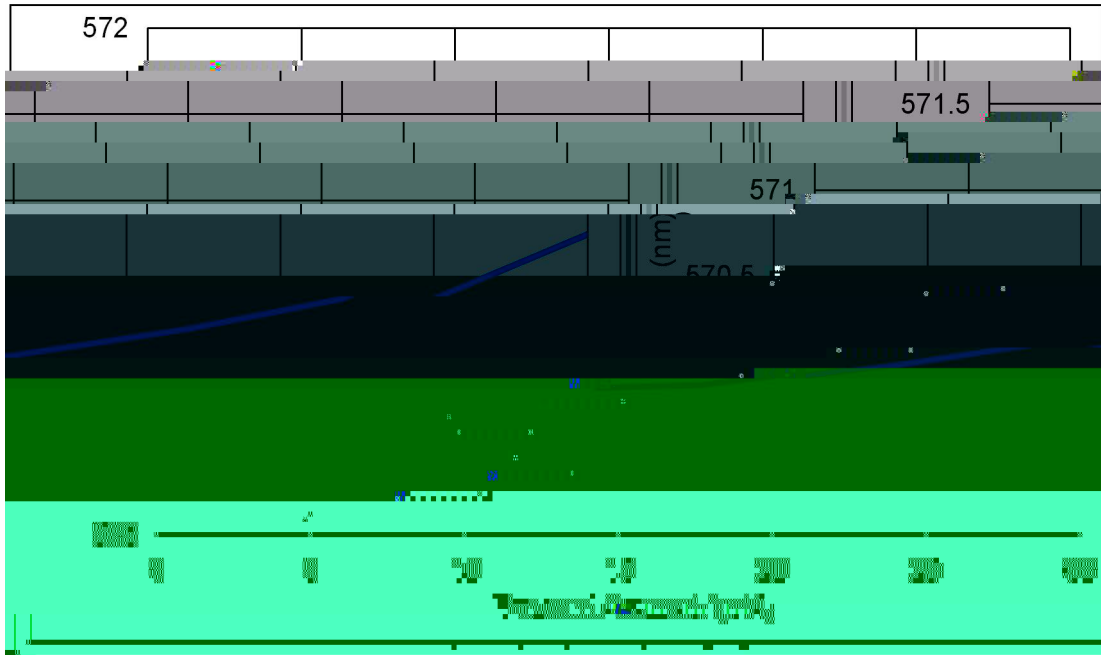

1-10

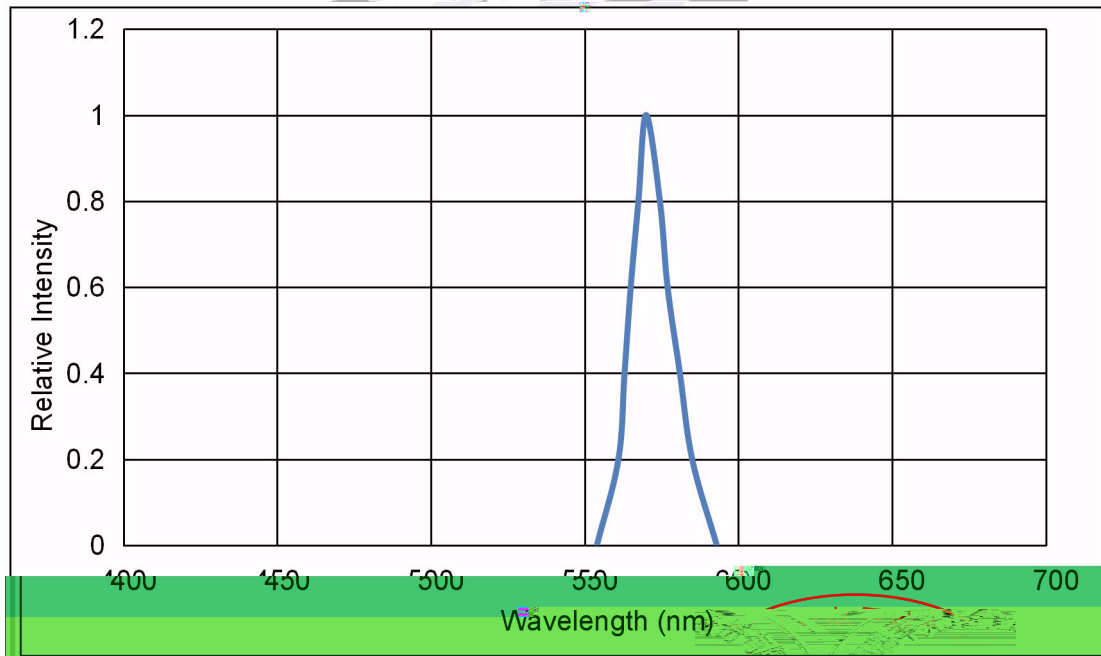

1-11

( $T = 25^{\circ}\text{C}$ ) 瑞豐光電 專認承

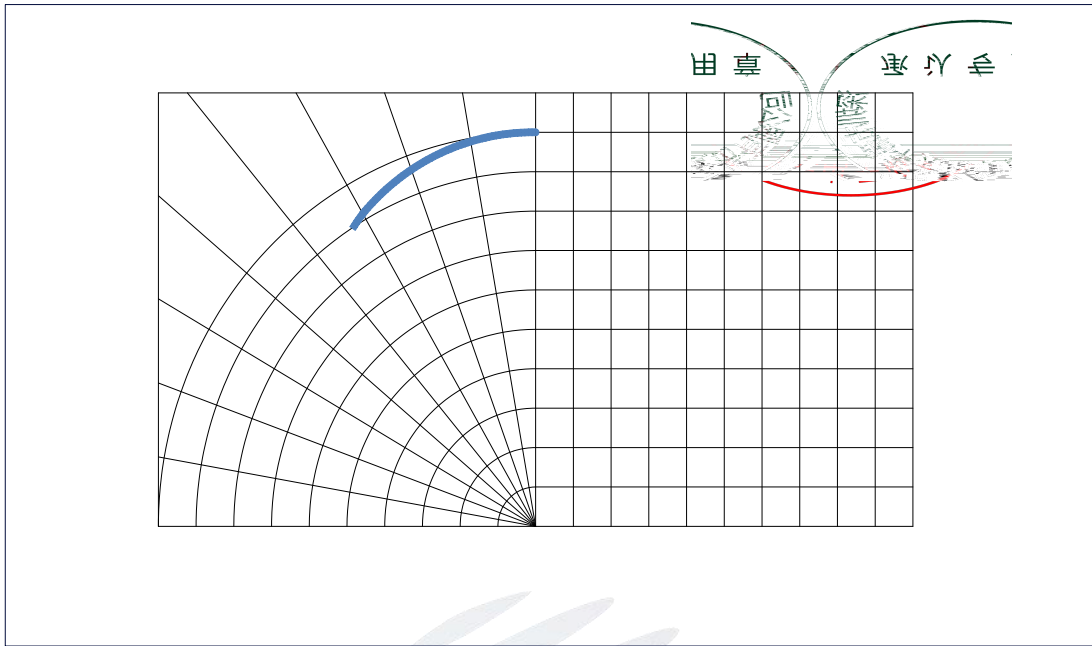

1-12



:4000 / . 4000

2.1.1

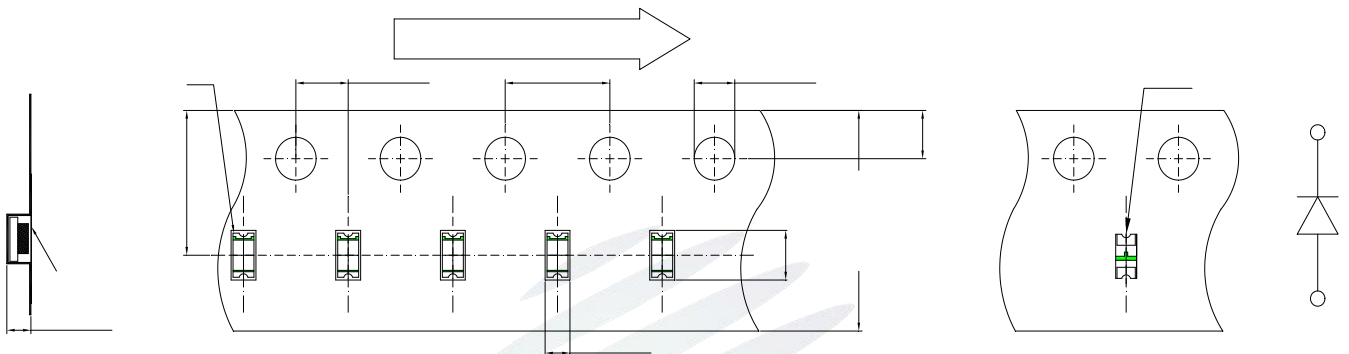

2.1.2

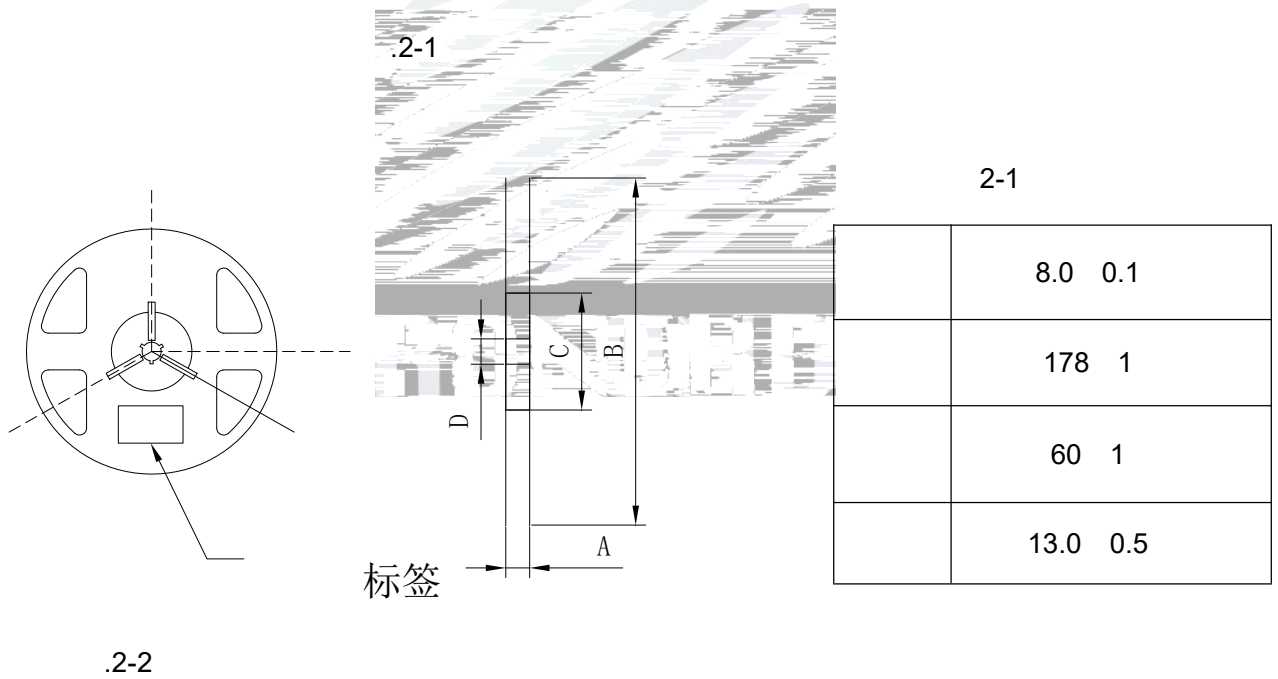

0.1 . :

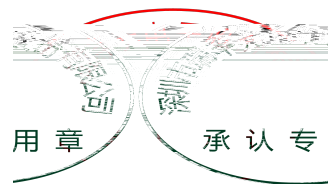

2.1.3

2-2

. 2-3



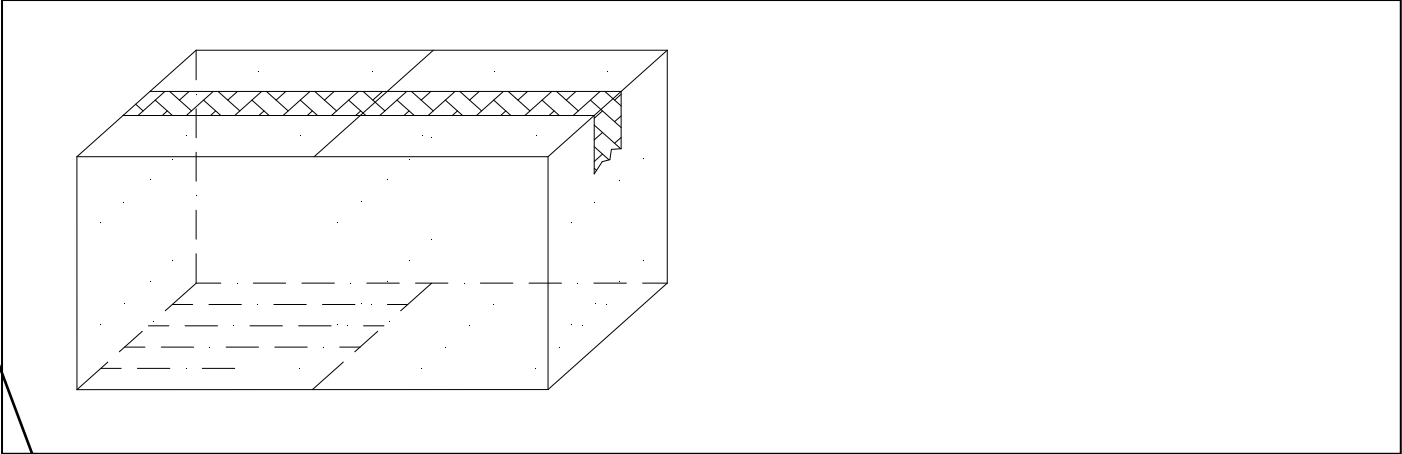

.2-5

2-3

					/
	22- 106	:260 =10	2	22 .	0/1
	22- 104	-100 30 5 -40 30	100	22 .	0/1
	22- 106	-40 15 100 15	300	22 .	0/1
	22- 103	:100	1000 .	22 .	0/1
	22- 119	:-40	1000 .	22 .	0/1
	22- 108	=25 =20	1000 .	22 .	0/1

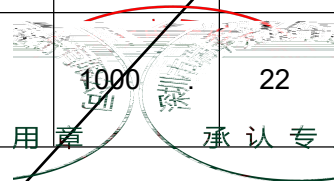

2-4

		=20	-	... *) 1.1
		= 5	-	... *) 2.0
		=20	... *) 0.7	-



1. ... :

2.

3.

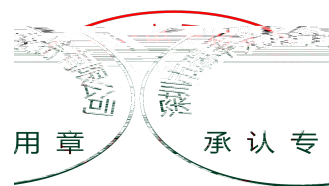

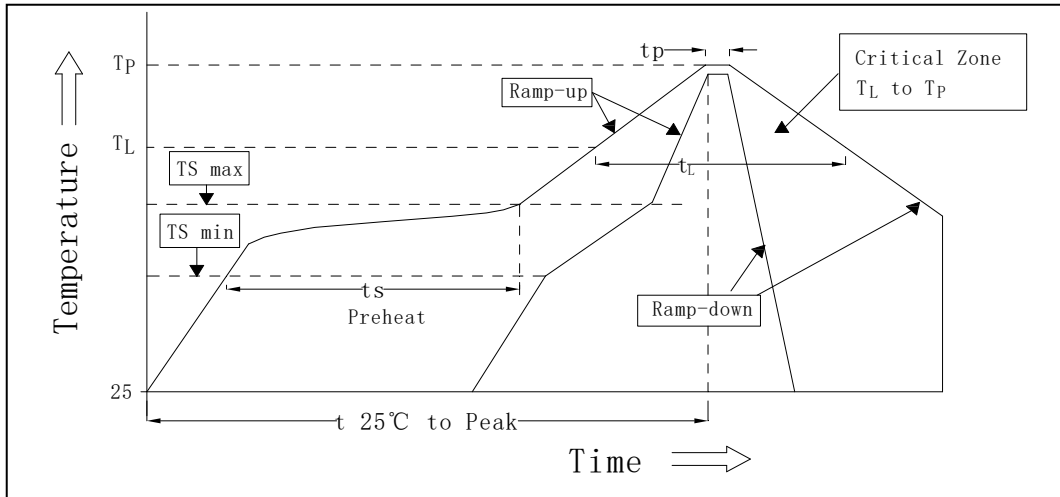

.3-1

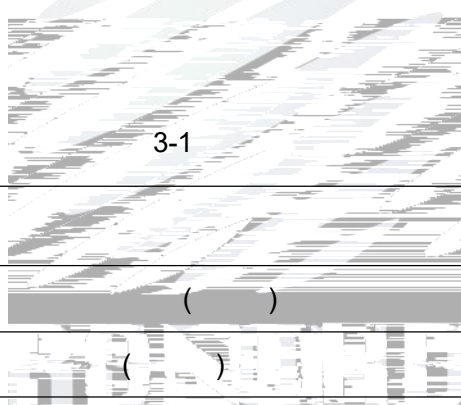

			3	/	3	/
:		( )	150			
:		( )	200			
:			60 - 120		60 - 120	
:		( )	217			
:		( )	60		60	
/	:	/	( )		260	
			10		10	
5	5	( )	( )		30	30
					6	/
25	25				8	8

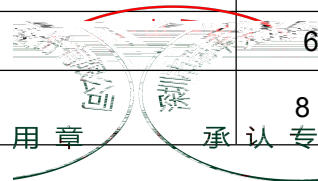

(1) 24

(2)

3.1.1

(1) 300°C 3

(2)

3.1.2



3.1.3

(1) ( )

(2)

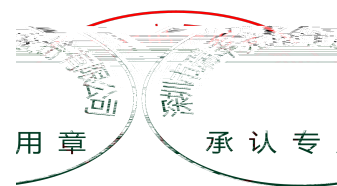



(1) 100

(2) 900 900



(3) ( )

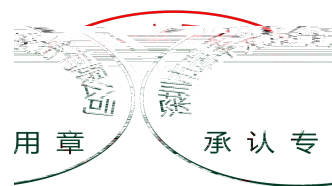

(4)

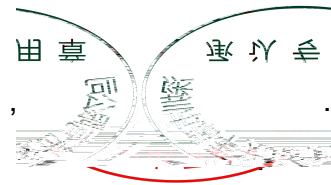

(5)

(6)

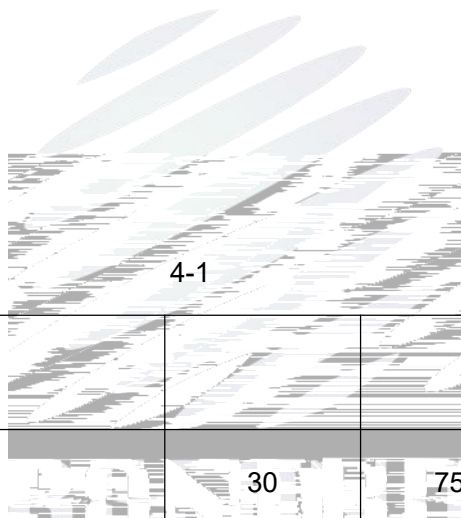

		30	75%	1
		30	60%	168 168
		60 5	-	24 24

(7)

(60 5) °C 24



(8) ; - ( )  
 ( ) .

(9) , .

