

SPECIFICATION

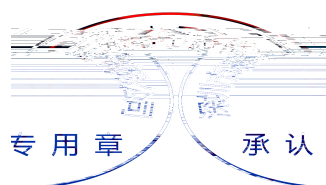

.....

.....

.....

.....

.....

.....

.....

.....

.....

..... 11

..... 11

..... 12

.....

.....

.....

.....

.....

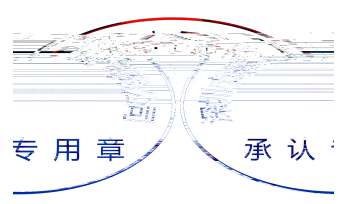

1. Description

1.1 General Description

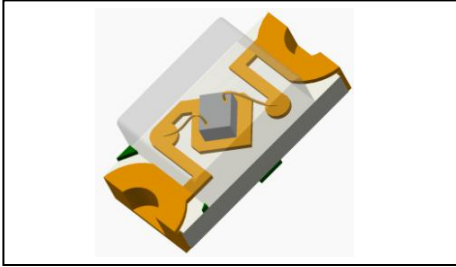

1.2 Features



1.3 Application

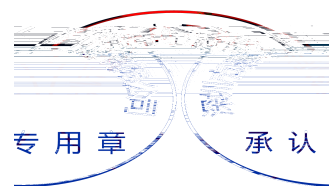

1.4 Package Dimension

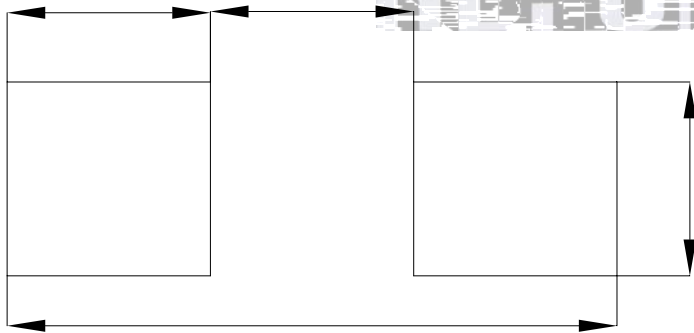
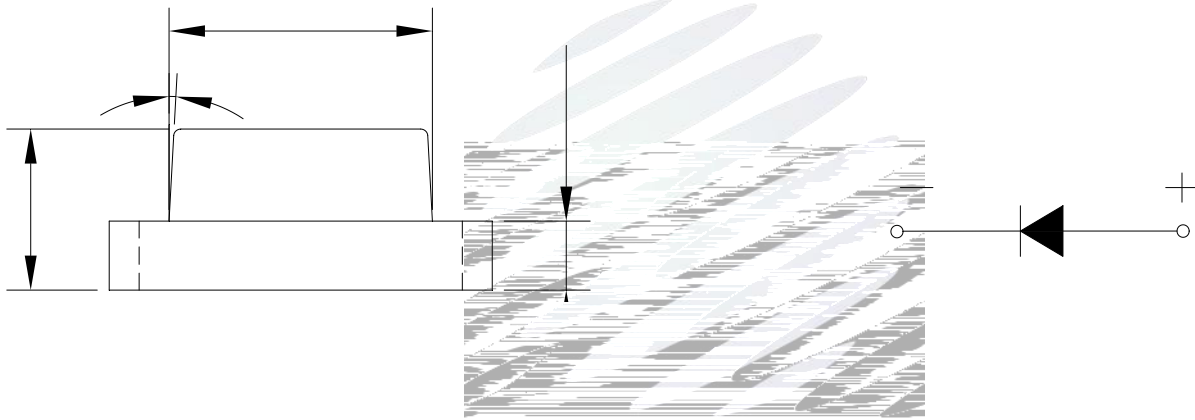
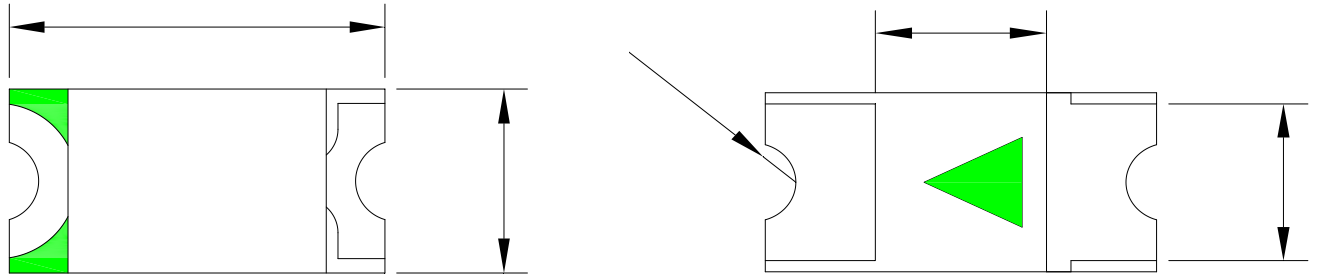

±

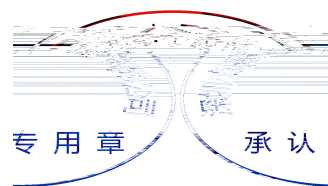

1.5 Product Parameters

						μ

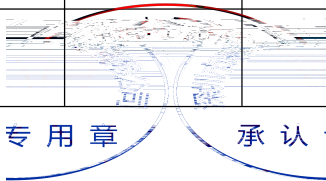

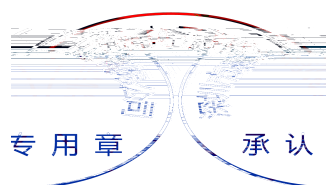

1.6 Typical Optical Characteristics Curves

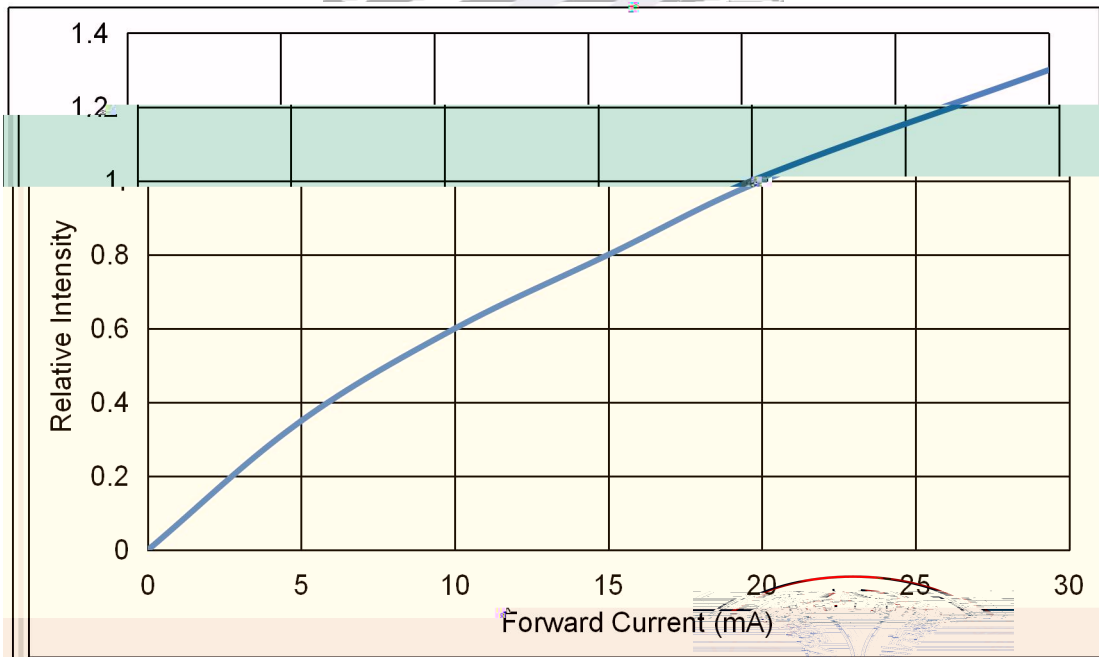
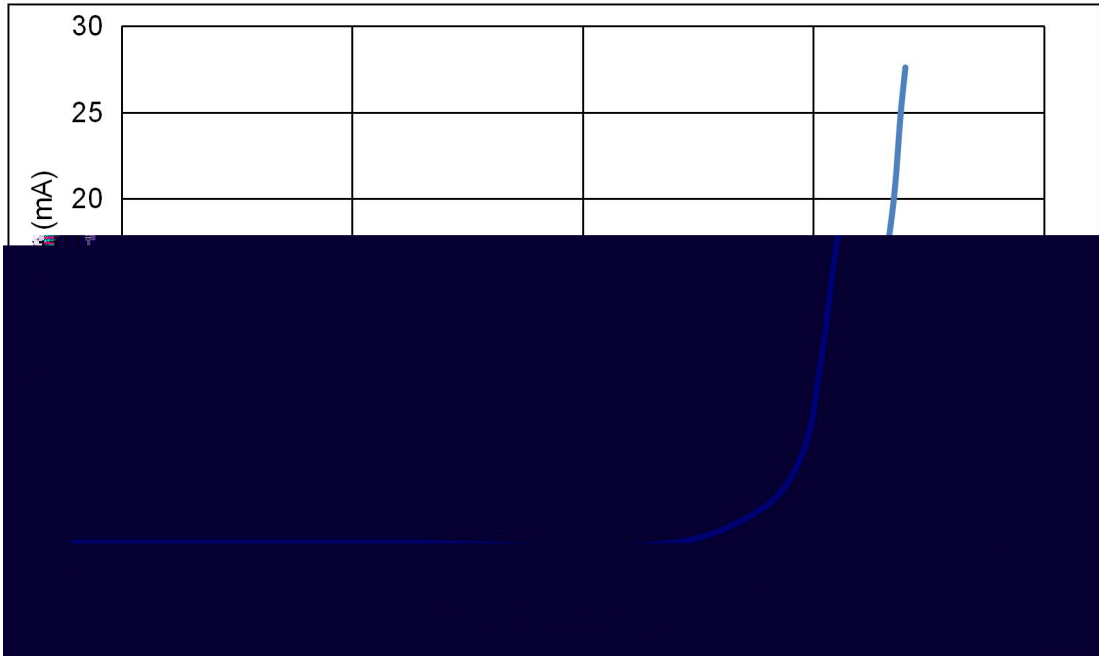

专用章 承认

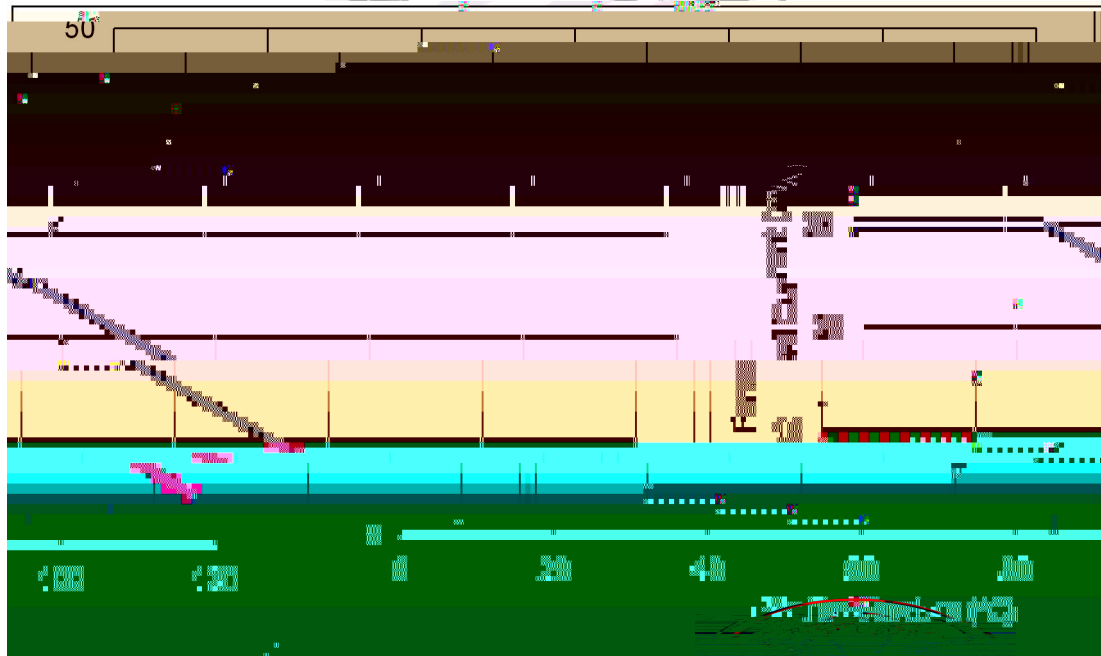
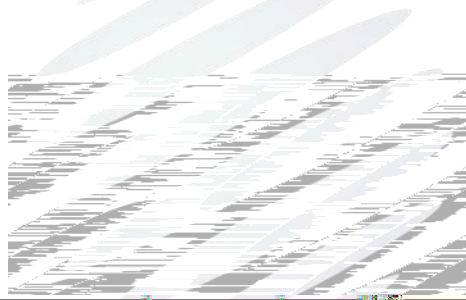
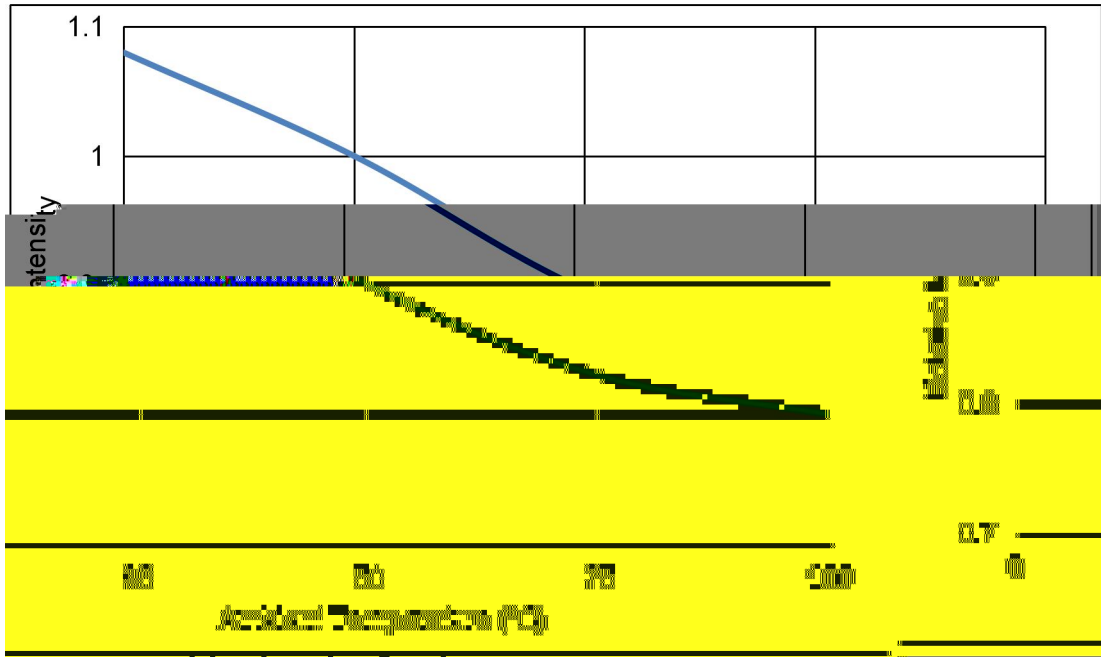

专用章 承认

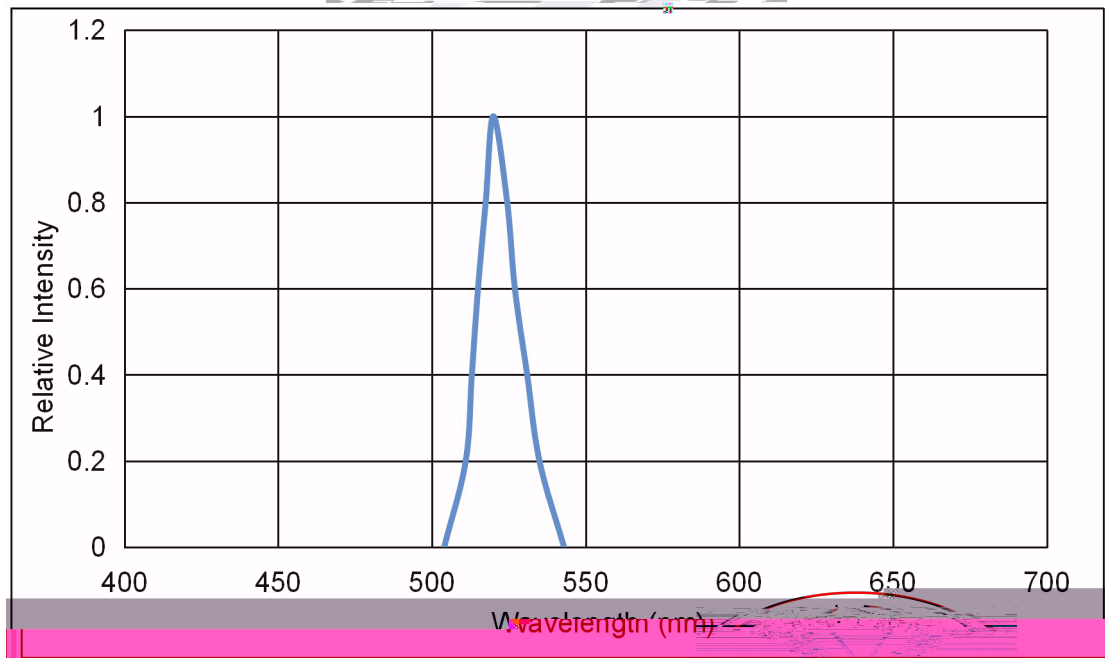
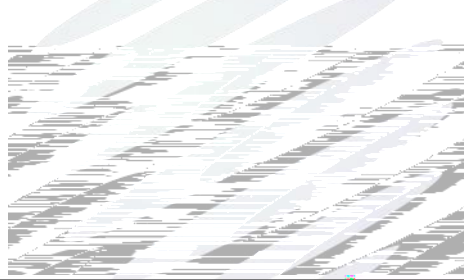
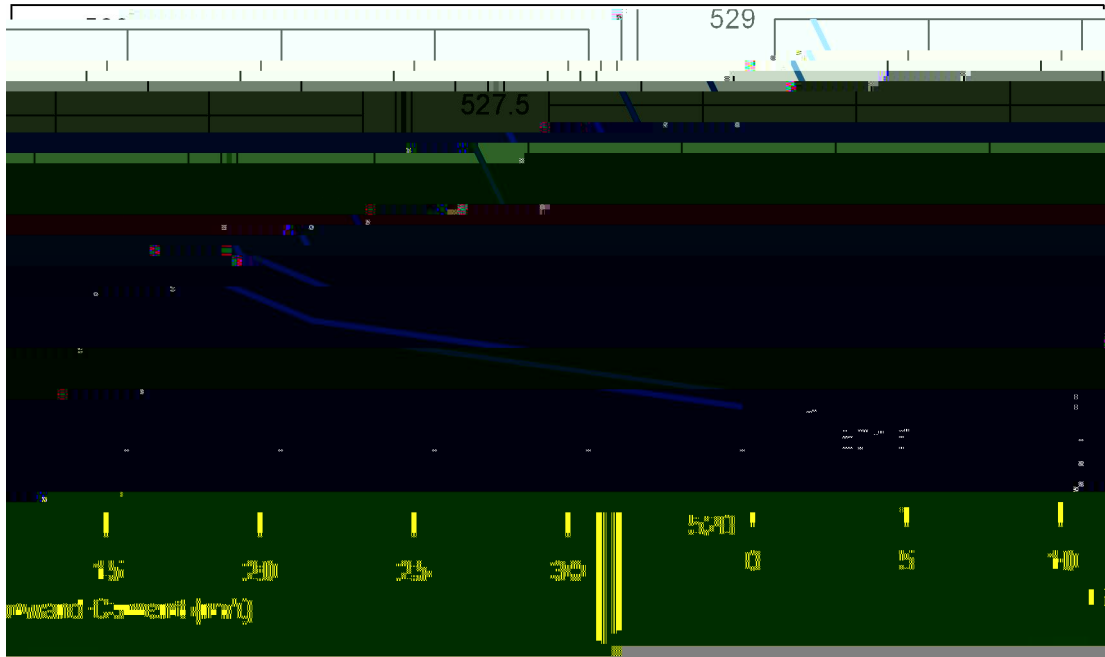

专用章 承认

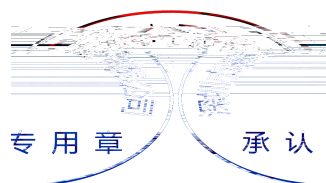
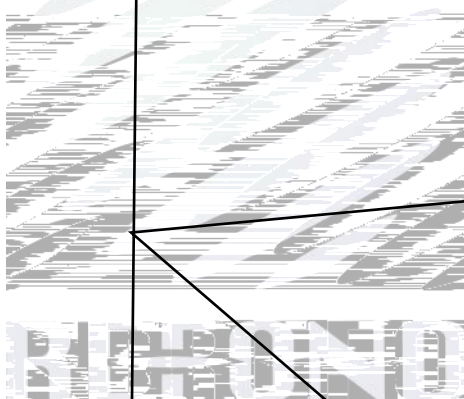
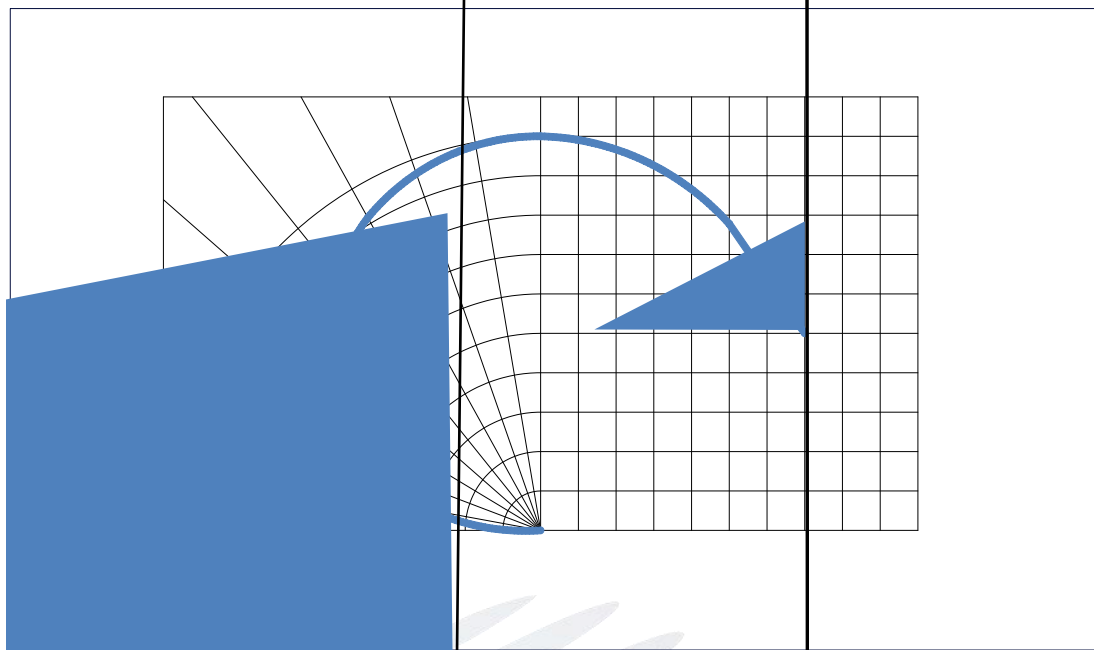

2. Packaging

2.1 Packaging Specification

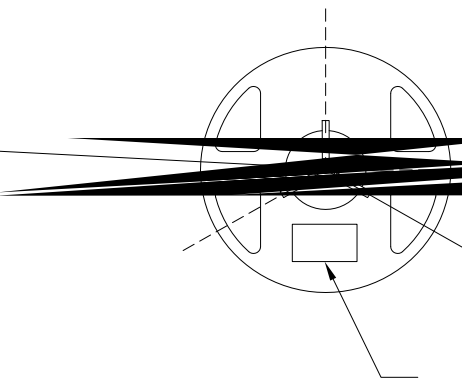
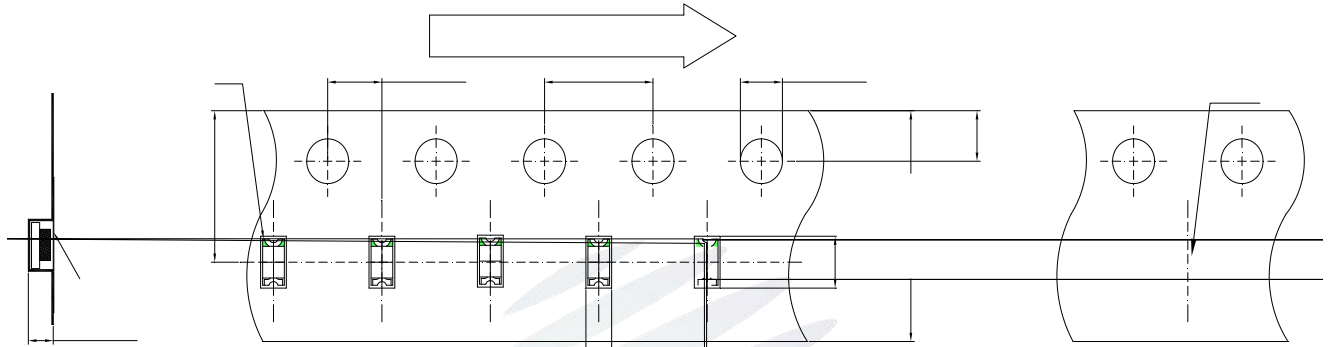

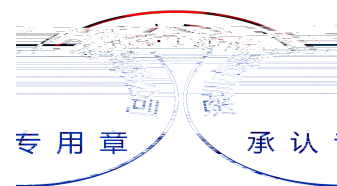



2.2 Moisture Resistant Packing

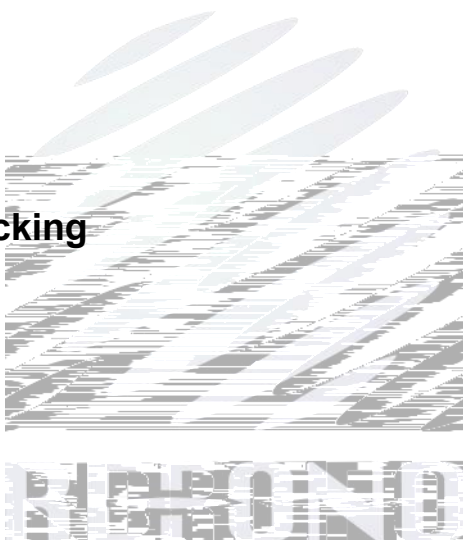

2.3 Cardboard Box

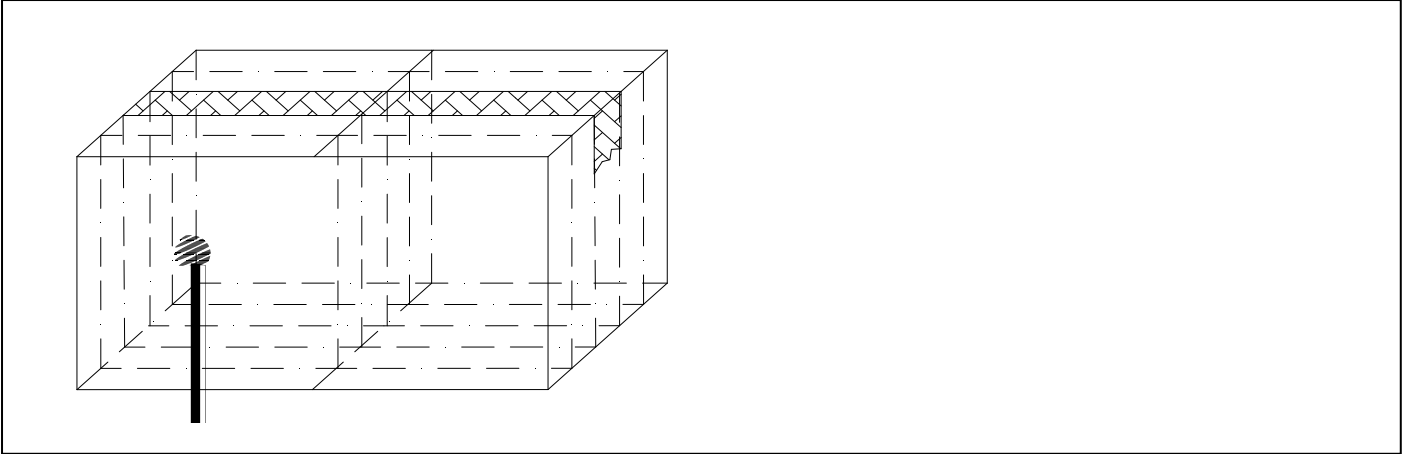

2.4 Reliability Test Items And Conditions



2.5 Criteria For Judging Damage

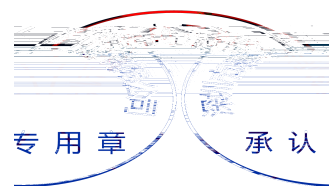

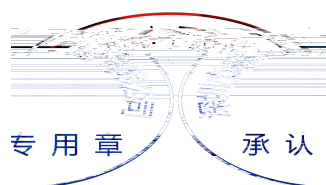

4. Handling Precautions

4.1 Handling Precautions

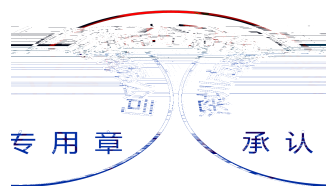



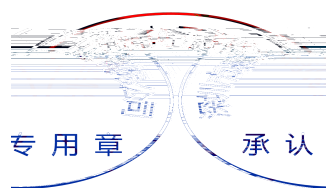

专用章 承认

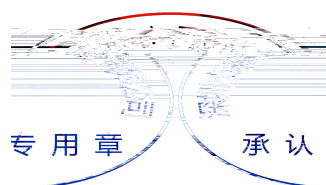

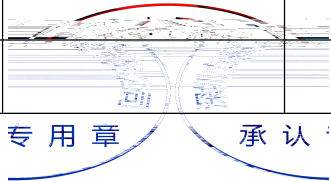
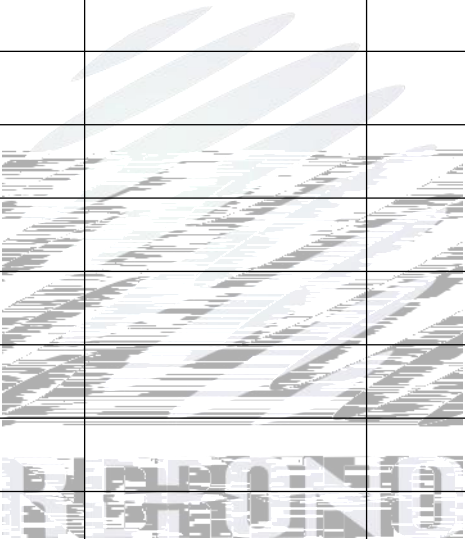

专用章 承认

